

REINVENTING
Europe

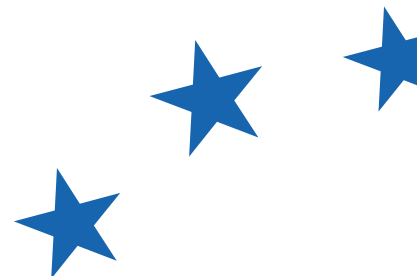

2024 MANIFESTO





2024 MANIFESTO

Table of Contents

Foreword by the President	6
Introduction by the Secretary-General	8
The Manifesto	11
The Priority Actions	19
a) Convergence & Strengthening DEMOCRACY AND GOVERNANCE - GLOBAL POWER EUROPE - CONSOLIDATION AND AUTONOMY - FUNDING COMMON PUBLIC GOODS - COHESION AND EQUITY - DIVERSITY AND INCLUSION - REFORMING THE EURO ZONE	23
b) Global Renaissance MIGRATION FLOWS - GREEN AND BLUE LEADERSHIP - ENHANCED HEALTHCARE - FOOD SOVEREIGNTY - DIGITAL REVOLUTION - 450 MILLION CONSUMERS	47
c) Plural Harmony EQUITABLE GROWTH - THE FUTURE OF YOUTH - QUALITY EDUCATION FOR ALL - CULTURAL WEALTH AND DIVERSITY - MEDIA AND PLURALISM - SPORT AND ETHICS	71
d) Vibrant Regions REGIONAL PROGRESS AND PROSPERITY - THRIVING OUTERMOST REGIONS	89

François Bayrou



The world is at a turning point. Never since the end of the Cold War has the future seemed so dark and dangerous. War has returned to our continent, the world's major powers seeking to control technology and whole economies, the calamitous effects of climate change are manifest, the global order is beset with ever-growing threats. The tight-knit alliance of the medium powers of Europe, joined in political integration, provides the only effective protection for our fellow citizens and for future generations.

The European Union was built piece by piece from the rubble of the Second World War, a disaster so terrible and so unprecedented in previous centuries and millennia that our continent was almost unable to recover.

Strong pioneering spirits – Jean Monnet, Robert Schuman, Alcide De Gasperi, Konrad Adenauer, Paul-Henri Spaak and, more recently, Altiero Spinelli, Jacques Delors and Bronislaw Geremek – brought the peoples of Europe together because they were convinced that helping each other, solidarity and shared interests would triumph over old feuds. We are their heirs and must champion this heritage. In shaping the Europe of tomorrow, it is our duty to show the same sense of history.

The very fabric of our democracies is being called into question by a series of violent upheavals. Russia's war on Ukraine is a crime against history. Driven by his desire to subjugate Ukraine, Vladimir Putin has broken a taboo and taken the senseless risk of wreaking havoc by breaching the bedrock of international law and one of the EU's founding principles: the intangibility of national borders. His rule has all the hallmarks of the most cynical dictatorship as he strikes down any who dare oppose him. In perpetrating the no less cynical terrorist attack of 7 October, Hamas succeeded in setting the Middle East ablaze, with considerable loss of life and dire consequences for international security. In China, demographic collapse is being used as a pretext for economic, technological and commercial overexpansion and for its imperialist threats directed at Taiwan. Locked in a divisive standoff pitting one side of public opinion against the other, the United States

threatens to return to brutal technological domination and turning its back on its allies, particularly those in Europe. All over the world, democracy is under attack, undermined by authoritarianism and populism.

This new era is affecting European society. The resulting inflation crisis is destabilising the already weakened social equilibrium. The far right is on the brink of power in many countries, adding fuel to our darkest fears. Traditional parties are falling apart and the dark clouds of populism are threatening democracies caught up in a crisis of representation.

Since our party was created, twenty years ago, the list of challenges has grown longer. And yet we have always been pragmatic in adapting our way of thinking. We have drawn lessons from the global financial crisis that had such a dramatic impact on so many citizens and highlighted Europe's growing economic inequality. Similarly, we have learned from the pandemic and from controversies related to our borders. These challenges have revealed weaknesses such as our perilous dependence upon manufacturing centres beyond our control.

2024 will therefore be a pivotal year. For the first time, we are not going into the European elections on the defensive. No-one can convincingly make the case that the role of the European Union in defending who we are and what we hold dear is anything less than vital.

On the eve of the 2024 European elections, we must reaffirm the crucial importance of European political integration. Reinventing Europe is an arduous task that requires unshakable will, and that is our foremost quality. We must shape the future of Europe so that justice, unity and common values shine through.

We the Democrats are determined to promote inclusiveness, solidarity and prosperity through dialogue with all European citizens. Their concerns will be the focus of our policies because we value them as partners in power. Our humanist, deeply pro-European voice must reach all who share our democratic values: the rule of law, respect for fundamental rights, identity and diversity, the promotion of social progress, inclusion, and solidarity between regions, peoples and generations.

We are one family. From Rome to Rotterdam, from Brno to Bilbao, from Ljubljana to Larnaca, from Venice to Vilnius, from Madeira to Munich, and from Strasbourg to Santa Cruz de Tenerife, we are all driven by reason and faith in building a European Union whose very existence and values are now under threat. We know full well that Europe can only survive and thrive if it is "united in diversity". Europe can and must, even beyond its borders, become a beacon of peace and determination in this troubled world.

Sandro Gozi

Here are a few words to introduce the methodology of this Manifesto, in which a health-related proposal is dedicated to our late colleague Véronique Trillet-Lenoir, an eminent doctor and respected politician who passed away on 9 August 2023.

We wanted this Manifesto to be as informative as possible so that readers could use our ideas according to their areas of interest and, by turning the pages, get to know us better and understand our philosophy.

But before we go any further, I would like to express my sincere gratitude to all our colleagues, working groups and member parties for their commitment and dedication to this initiative. Without their valuable input, this process would not have been possible.

So, how did we come up with this manifesto? It consists of two separate elements for greater clarity:

- **THE POLITICAL MANIFESTO, which outlines and illustrates the principles and values of our party,**
- **THE (SPECIFIC) PRIORITY ACTIONS detail the concrete measures to be taken.**

Thus, the following pages show that each of the 21 themes I discuss is presented as a double-page spread.

- **The left-hand page summarises the broad political message of the issue in question.**
- **The right-hand page outlines the priority actions.**

As you can see, all the proposed actions (right-hand page) start with an action verb to instil the idea in the reader's mind that we are on the move and have the will to move forward. How did we come up with 300 priority proposals?

300 may seem a daunting number, but we have developed a rigorous process to achieve this result, structure our message, and ensure that everyone uses the same language.

Under the leadership of one or more elected officials, each working group conducted an in-depth analysis of the problems and opportunities specific to its field and formulated concrete proposals to solve them.

Following a meticulous review of all the work, we have drawn up 4 chapters:

Convergence & Strengthening - Global Renaissance - Plural Harmony - Vibrant Regions

21 key themes were identified:

Democracy and Governance - Global Power Europe - Consolidation and Autonomy - Funding Common Public Goods - Cohesion and Equity - Diversity and Inclusion - Reforming the Eurozone - Migration Flows - Green and Blue Leadership - Enhanced Healthcare - Food Sovereignty - Digital Revolution - 450 Million Consumers - Equitable Growth - The Future of Youth - Quality Education for All - Cultural Wealth and Diversity - Media and Pluralism - Sport and Ethics - Regional Progress and Prosperity - Thriving Outermost Regions

These categories enabled us to sort and group all the proposals, considering their relevance, feasibility and impact. Duplicates and similar proposals have been identified and grouped under the most appropriate themes. We then ran them through a prioritisation process, which resulted in 300 being selected.



/300 OUR PRIORITY ACTIONS FOR 2024



Manifesto



A stronger more united Europe

At the heart of our democracies lies a fundamental act: the right to vote. During the European elections, from the 6th to the 9th of June 2024, we have an unprecedented opportunity to fulfil our civic duty by voting. Why is this of such crucial importance?

First, this unique opportunity to choose our MEPs sets us apart from the rest of the world. Thanks to direct universal suffrage, we can actively participate in the election of a continental parliament. In addition, a supranational parliament therefore gives power to every European citizen.

Recognising the importance and significant impact of your vote, our party has a clear and ambitious manifesto presenting our ideas, priorities and measures to defend and promote democratic expression, citizen representation and the dissemination of political ideas on a European level.

Our goal is to create a more committed, inclusive and prosperous Europe where citizens are at the heart of decision-making. In this period of major societal change, our democracy must reach its logical conclusion. We therefore wish to create a Europe where citizens are active partners in political life. We are committed to bringing the European institutions closer to their citizens and are campaigning for them to be able to elect a true President of the European Union, just as they elect their mayors; for them to be able to vote directly for European political parties in the same way they do at local and national levels. Therefore, the need for a new form of transnational politics is inevitable. For us, it is essential to go beyond national borders to choose our representatives in the European Parliament. Instead of European elections with 27 national debates, we must focus on a truly European debate and politics. This will allow us to face major challenges together, take collective decisions and shape our future with more legitimacy and effectiveness.

We are deeply convinced of the intrinsic value of every individual, wherever they may be. Our objective is to persuade all those who advocate for a more sovereign, democratic, and humanist Europe and those who look to transcend the splits and schisms that populists and nationalists exploit to undermine our European values by deepening divisions. The European Union we dream of is a place where everyone can reach their full potential and live their European citizenship to the fullest, regardless of their gender, sexual orientation and gender identity or expression,



age and generation, social origin, ethnic origin and nationality, religion or faith, or physical and mental ability.

Equality between men and women in the European Union has made significant progress over recent decades, but there is still a long way to go. We must ensure that men and women achieve full equality in all aspects of life as quickly as possible. We must also eradicate gender-based violence, which remains a major problem in Europe.

Our vision of a diverse society goes beyond the fight against discrimination: we are fighting to build a society where differences are not only accepted, but celebrated. Recognition and respect for universal human rights are an integral part of our European culture, and we will strive to remove all obstacles that stand in the way of building a fully inclusive society.

We seek to strengthen this Europe of solutions, which will provide real answers and create numerous opportunities for our regions and their citizens.

However, Renew Europe did not wait for this deadline to act. Since 2019, our political group has become a key player in the European Parliament. Thanks to our collective intelligence and alliances, with Emmanuel Macron's leadership, we have delivered our promises by revitalising the foundations of a dynamic and powerful Eu-

rope, while prioritising concrete and pragmatic action.

We are proud of the tangible results achieved during this legislative term. Although the foundations on which our society was built have revealed certain weaknesses and highlighted the limits of old assumptions about free trade, openness without reciprocity or a certain naivety towards major trade issues, we will be known for being at the origin of considerable progress. These include the new rule of law conditionality regulation, which prevents allocating funds to those not respecting European values. We have also promoted key initiatives such as the Green Deal, new laws on digital services and markets, COVID-19 vaccines, the Recovery Plan, the Pact on Migration and Asylum, the introduction of transnational lists and the holding of the Conference on the Future of Europe. The latter represented a first in Europe's history, allowing direct citizen participation on a continental scale.

We firmly believe that European sovereignty and strategic autonomy are essential to preserve our freedoms, and it is time to define our vision for Europe clearly.

We want to fight for a continental strategy adapted to new challenges and requirements. The principle of living together as Europeans must guide us while ensuring our continent's security, development and boosting cooperation.



We want a more engaged, inclusive and prosperous Europe where citizens are at the heart of decision-making, from their local community to the European Union.



“ Together, we can shape a better future where the values of freedom, democra- cy, equality and solidarity are fully achieved.

This is why we support the proposal for a European political community. Its mission will be to strengthen the links between the Member States of the European Union, the candidate countries in the process of joining, as well as the European countries that have chosen not to be part of our Union. It is essential to ensure consistency of action and promote a sense of shared community within this new architecture of continental cooperation and security.

In this context, it is evident that the European Union, as it currently exists with its institutional structure, is not ready to play this new geopolitical role nor to welcome new members. Essential reforms without totems nor taboos are necessary to meet these challenges.

We must reorganise the European continent and, to cite only the main reforms, we must establish a defence union and an energy union by eliminating the right of veto, facilitating the initiatives of peoples and states who wish to accelerate their political union, creating new own resources and strengthening the European Parliament while reducing the number of Commissioners. Reforming the treaties to achieve these essential changes and move forward with continental unification is imperative. We must

aim for a sovereign Europe that will truly allow us to regain control of our destiny.

The European Union was designed to strengthen the various levels of governance, whether local, national or supranational, rather than to weaken them. Our party's approach is that in the same way that cities strengthen regions, strengthening nations make the European Parliament stronger... And vice versa. The goal is to promote upward and downward collaboration between the different levels of government and democracy, thus creating a more solid and effective structure. We will also promote a new cooperation strategy between the different generations for real solidarity between the youngest and the oldest.

When we talk about Europe, our commitment ranges from the continent to the oceans and to the outermost regions. We are determined to place the outermost regions as one of our primary concerns and to give them the recognition they deserve as regions with solutions and of strategic geopolitical importance. These regions are fully part of the European Union, and we want them to feel this ever more strongly and urgently.

Our ambition is to make Europe a beacon of excellence and innovation, focusing on the well-being of our fellow citizens and building a promising future for generations to come. That is why we want to strengthen the protection of citizens, regain control of our destiny, fully harness the potential of artificial intelligence, consolidate our common defence, responsibly manage migration challenges and ensure thoughtful climate protection.

The ecological transition must be pragmatic and inclusive, guided by technology, far from ideological dogmatism and in no way punitive towards families, businesses or professionals in the primary sector, farmers and fishermen. It is the European Union itself that must take charge of this transition. This means reforming European budgets and creating new financial

resources, such as a carbon tax at borders. We want to promote renewable energies by offering financial incentives to encourage the transition to a green and blue economy. We will actively support companies that develop clean technologies, and we will continue our efforts to help small and medium-sized enterprises.

For us, the digital, ecological, and maritime transitions are the essential pillars of our 21st-century Europe, just as coal and steel were in the past. Our proactive approach pushes us to build a resilient, prosperous Europe in harmony with our environment. We will support balanced and pragmatic policies to reduce carbon emissions, promote renewable energy and encourage the adoption of cleaner modes of transport.

We are convinced that innovation and research will play a crucial role in Europe's growth and competitiveness, and we will make massive investments in cutting-edge technologies, taking into account the needs of all generations.

For us, artificial intelligence represents an opportunity for humanity, and we trust it. Moreover, we will promote the freedom of companies and creators in this field because it will create jobs and facilitate the lives of children, students, parents, and grandparents. We want to promote a new strategy between generations thanks to artificial intelligence. Artificial intelligence will be the key to the future, and we must regain the time we have lost compared to China and the United States in this sector. This evolution will take place in full respect of the prin-

“
The principle of living together as Europeans must guide us while ensuring our continent's security, development and boosting cooperation.

ciples and freedoms that lie at the heart of our model of society. At the international level, we are committed to building a new governance of artificial intelligence with the United Nations. However, innovation must not relegate culture to the background.

On the contrary, culture must benefit from the same resources as those allocated to security. We are firmly convinced that a democracy at risk is culturally impoverished. Hence why we call for every 1 euro spent on security that another 1 euro should be invested in culture.

Culture was, is, and always will be the best asset for the future of our youth and the natural barrier against nationalist and populist ideas. We recognise its essential role in preserving our society's values and identity.

We are firmly committed to continuing and intensifying our initiatives to guarantee and improve their daily lives. This includes strengthening their protection as consumers and reducing social, generational and regional disparities. We strongly push for policies and regulations to fight against planned obsolescence and a fairer and more sustainable single market for producers and consumers.

At the heart of our conviction lies the imperative of involving the people and including regions. We will reduce the gap between reality and the public's perception of European institutions. With this in mind, we will pay close attention to urban and rural dynamics, even down to the most concrete details.

The crucial role of mayors will finally be recognised as the leading actors in our approach to European politics. Their proximity to citizens and their understanding of local needs gives them an invaluable influence in implementing our vision. By involving citizens, highlighting regional specificities and valuing the power of councillors, we will build a Europe that is more democratic, participatory and anchored to what people live every day.



Our vision of a diverse society goes beyond the fight against discrimination: we are fighting to build a society where differences are not only accepted, but celebrated.

We aspire to a Europe that promotes harmonious coexistence in all its diversity. Recurrent migration crises have highlighted the need for a unified approach. Thus, we will implement an asylum and immigration policy that is humane and fair, respecting the fundamental rights of each individual while ensuring the security and successful integration of migrants. Our commitment will turn towards a migration policy based on solidarity between Member States and support for initiatives to address the root causes of forced migration. We will also strive to establish common rules to tackle the challenges of economic and climate migration. Furthermore, recognising the urgent need to ensure that Member States in the South are no longer left to police vast stretches of maritime borders on their own, we will actively support the implementation of the new partnership between Europeans and Africans, launched in February 2022 under the French Presidency of the Council. This partnership is essential to the development of a continent undergoing rapid demographic expansion.

By supporting Africa as a friend and partner, we aim to control the outflow of its citizens to Europe better. We will mobilise civil society and young people from both continents to make this vision a reality. We are convinced that diasporas will be 'renewable energy sources' that will propel this new strategy of shared growth and prosperity.

Successful integration requires European policies that include cities and regions upstream and downstream. Citizens are integrated at the local level, and the regions provide most of the services they need, such as healthcare and education. Better knowledge of employment and integration opportunities is also found at the regional level, as is the combination of these needs with active employment policies. Many regions are also active in cooperation. Failing to capitalise on this knowledge dehumanises European immigration policies.

We are determined to build a strong Europe because it also means a united and influential Europe on the world stage. In an era marked by the emergence of new empires, such as China or Russia, we want to strengthen integration between Member States in security, defence and foreign affairs.

We will promote initiatives by groups of countries willing and able to go further and faster regarding defence and security integration. This includes support for creating a genuine European military force capable of dealing effectively with security crises and threats and new hybrid threats.



The revision of the treaties must be aimed at a sovereign Europe that will allow us to truly regain control of our destiny.

Strategic autonomy is essential if we are to develop a genuine European pillar within NATO and strengthen our alliance with the United States. Together, Europeans and Americans, we aspire to promote a new alliance for democracy on a global scale.

Moreover, unlike nationalist parties that prioritise their particular and electoral interests, establish alliances with powers outside Europe, manipulate the media and interfere in the

economy of our democracies, we are committed to taking concrete action to ensure our collective autonomy and security in partnership with all other democracies in the world.

Health is an essential part of our manifesto. This is why we recognise the crucial importance of autonomy in terms of healthcare and proposes to strengthen Europe's capacity for action and relocate the production of medicines and medical equipment within the Union.

By ensuring full coverage of the strategic product value chain, this measure will strengthen our ability to meet the healthcare needs of our citizens while reducing our dependence on external sources. Thus, adequate medicines and medical equipment availability will be guaranteed, increasing our resilience during health crises. By using new common standards and sharing data with doctors and health professionals, we can also benefit from technological advances at the service of citizens while developing major European research centres.

We want to give our young people every opportunity to succeed and fulfil their potential without being held back by social, economic or geographical obstacles. This will require a concrete and effective youth policy for the European Union, capable of providing the tools it needs.

With the European elections just a few months away, we are ready to say loud and clear that we want a Europe where debates belong to the people. We will always vigorously defend our vision for a humanist European society.

Europe is a multiplier of opportunities, rights and protection for our people, especially the most vulnerable.

Therefore, the time has come to set in motion a new political dynamic and reinvent ourselves. To build a better and more resilient future, we offer innovative solutions to continue the European transformation that started in 2019 and remedy the flaws that could alter our foundations. We are sure that the pro-European central forces will increasingly become the driving force behind the European recovery.

We call on all Europeans to join us in this campaign for a strong and united Europe.

Together, we can shape a better future where the values of freedom, democracy, equality and solidarity are fully achieved.



The world is changing. Borders are shaking. Countries are becoming tense and fractured. Like tectonic plates, they scrape against each other. By joining forces, we can reinvent a Europe that is stronger, more democratic, more progressive, and ready to meet the challenges of the 21st century.

The global challenges are immense and we will not let hatred cloud our vision. And that is why it is with a heavy heart that we speak of the “Israeli 9/11”.

What happened in Israel on 7 October 2023 was not a terrible act of war nor a demonstration of territorial or nationalist claims. No, it was the pure hatred of a heinous monster that erupted from the Gaza Strip. Its name is Hamas.

Some are looking for words to describe the unspeakable, but silence, as we in the European Democratic Party know, is always on the worst side. It hides the truth; it obscures reality. In reality, there will be no lasting peace without recognition of the legitimate right of the Palestinian people to a territory and a state. Nor will there be any lasting peace unless the Palestinian people and the Palestinian Authority recognise the State of Israel and its security.

Peace is the unique bond between people. Peace is the essential bond that enables us to face global challenges together.

We will continue to fight tirelessly for peace. It is our commitment, our duty to humanity. The challenges lie ahead, and European Democrats will rise to meet them.



Time to act...



Join us.



a)

Convergence & Strengthening

Convergence & Strengthening

DEMOCRACY AND GOVERNANCE 26

Democracy and governance are fundamental pillars of any prosperous society. For us, this means transparency, citizen participation and the responsibility of the European institutions.

GLOBAL POWER EUROPE 30

Europe must act as a global power to face the growing global challenges. We are committed to a more robust Common Foreign and Security Policy, greater cooperation in the field of defence and a unified voice on the international stage.

CONSOLIDATION AND AUTONOMY 32

Strengthening Europe's consolidation and autonomy in key areas such as technology, innovation, energy, and security is essential. We want to invest in research and development, creating strategic partnerships between companies and encouraging entrepreneurship.

FUNDING COMMON PUBLIC GOODS 36

Common public goods, such as environmental protection, public health and scientific research, are essential to the well-being of all European citizens. We aim to put adequate funding for these sectors in place to ensure a better and sustainable quality of life.

COHESION AND EQUITY 38

The European Union has a duty to promote solidarity and equity among its member states. We are committed to minimising economic and social disparities by investing in less developed regions and facilitating access to education, training and high-level employment opportunities while guaranteeing equal opportunities for all citizens.

DIVERSITY AND INCLUSION 42

We want a united, equitable and inclusive Europe where everyone is respected and can live fully and freely. We must stand up for universal human rights and remove all obstacles to an inclusive society, embracing transgender, transgenerational and transnational diversity.

REFORM OF THE EUROZONE 44

Recognising the vital importance of the eurozone, we propose implementing a specific budget to boost economic growth while providing concrete support to countries in difficulty. We are committed to closely coordinating budgetary and fiscal policies within the eurozone to avoid significant economic imbalance.

PRIORITY ACTIONS

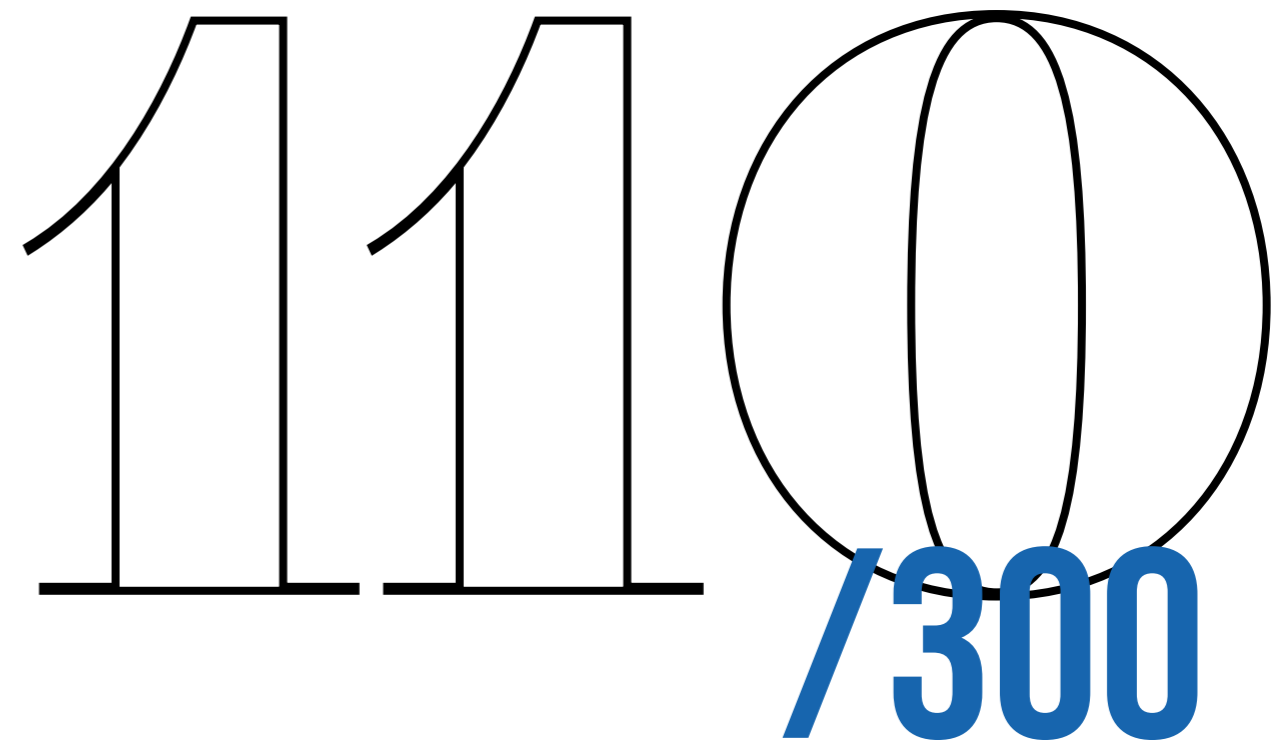

DEMOCRACY AND GOVERNANCE

The current European treaties mark more than 15 years of progress for Europe. However, the European Union now faces a unique opportunity to strengthen its institutional structure and become a sovereign and democratic Europe. To go even further, we can work to create a genuine political union based on solidarity. We, the European Democrats, call on Europe to take back control of its destiny by strengthening the continent's sovereignty and autonomy. Building a united political community will ensure a positive future for Europe, meeting the challenges of populism and violations of international law with constructive and inclusive solutions. To meet the challenges ahead, whether societal, environmental or security-related, the European Union must act more quickly and effectively. We want to build a prosperous and resilient future for our continent. Together, we can ensure that Europe is a positive force for its citizens and the world.

Furthermore, to strengthen democracy, we must establish the possibility of electing a president of the European Union from electoral lists common to all EU countries.

And if citizens are to renew their ties with Europe and its institutions, direct involvement in the political life of the Union is essential. Waiting for the European elections every five years is no longer enough to promote citizen participation. We propose an innovative step:

setting up a Citizens' Agora mechanism. Every spring, national and European Citizens' Agoras would meet to debate and propose priorities for Europe. These exchanges would feed into the annual programme presented by the President of the European Commission each September during the State of the Union address. By offering citizens this platform to express themselves actively, we will encourage direct participation in shaping Europe and strengthen all citizens' sense of belonging and commitment to Europe.

Democracy must be strengthened by including citizens in political decision-making. By providing transparent information, treating citizens as partners and actively involving them, we guarantee democratic stability and avoid many problems.

25/300

PRIORITY ACTIONS

- Establish a treaty revision convention to abolish unanimous voting in the Council.
- Implement the proposals of the Conference on the Future of Europe to meet the demands of European citizens in this field.
- Facilitate the faster political integration of groups of countries and peoples who demonstrate the political will to do so without the possibility of blocking by others.
- Establish the possibility of electing a president of the European Union from electoral lists common to all European countries (merging the President of the Commission and the President of the European Council).
- Include transnational lists in European Parliament elections.
- Provide the European Parliament with legislative co-decision rights when it plays an advisory role and co-decision rights on the budget, including revenue.
- Grant Parliament a genuine right of a legislative initiative to complement the European Citizens' Initiative.
- Strengthen the role of the European Union in areas such as health, education and energy.
- Introduce an emergency clause to authorise the European Union to act with extraordinary powers in a major crisis.
- Strengthening European political parties and foundations would increase their viability.
- Ensure transparency in funding political parties and election campaigns and prohibit international interference.
- Strengthen the capacity of political parties and movements to conduct transnational political campaigns.
- Activate the clauses allowing qualified majority voting for certain EU decisions. This will avoid the blockages that can occur with the current unanimity system.
- Implement temporary passerelle clauses to allow for significant legal and institutional changes using simplified procedures.
- Improve the voting rights of residents in another Member State at European elections.
- Facilitate the participation of European citizens residing in another Member State by enabling them to vote and/or stand in their country's regional or national elections.



ENDING VETOS



DIRECT ELECTION OF THE EU PRESIDENT



TRANSNATIONAL LISTS



MORE POWERS FOR PARLIAMENT



SIMPLIFYING VOTING ABROAD

- Propose the creation of a European agency to strengthen democracy in the decision-making process, citizen participation within the EU and the role of national parliaments.
- Ensure equal opportunities for all EU citizens, and pay particular attention to the most vulnerable and marginalised.
- Encourage citizen participation by using new technologies.
- Create a European citizenship statute based on the existing treaties.
- Establish a statute for European cross-border associations.
- Continue to promote the role of local and regional authorities in climate and biodiversity policies through subnational climate diplomacy.
- Develop a pilot project on promoting European values through education and culture, including identifying best practices at local and regional levels throughout the European Union, as the Committee of the Regions decided.
- Clarify that subsidiarity is not about preventing the European level from acting but about identifying the level of government that should take the lead, whether through formal exclusive powers or formal shared powers.
- Grant national and regional parliaments with legislative powers the possibility of suggesting legislative initiatives at the European Union level in the future by providing a specific mechanism for this purpose in the regulation governing the European Citizens' Initiative.
- Change the names of the European Union's institutions to clarify their functions and respective roles in the European Union's decision-making process for citizens.

“

The European Union
must act more
quickly and more
effectively

GLOBAL POWER EUROPE

European Democrats are profoundly convinced that peace is the cornerstone of any prosperous civilisation in Ukraine, Israel, and the world. In this spirit, we will strive tirelessly to cultivate peaceful relations, promote non-violent conflict resolution and a culture of peace on a global scale.

We are determined to fight corruption, human rights abuses and political repression. We will promote international justice and security, particularly in neighbouring countries, while combating external interference.

We will strengthen cooperation with our partners who share ideas based on mutual respect and common values. We aim to play a leading role in the reform of multilateralism and promote our values within international cooperation.

We want to consolidate the European Union's position and influence globally by promoting its strategic autonomy and speaking with one voice.

We want a genuine Common Security and Defence Policy. The EU's internal and external security is one of our priorities in the face of hybrid threats, which represent a major security challenge. We will propose strengthening European security agencies and intensifying

cross-border cooperation to achieve this. We will support specific actions such as establishing joint European intervention forces and purchasing military equipment.

With regard to migration and asylum (see the Migration Flows chapter), we want to align European policies and improve the protection of the European Union's external borders.

We are determined to combat arms trafficking, with a particular focus on the post-war period in Ukraine.

We believe in a world where peace is not just an ideal but a reality for everyone, guaranteeing a safe and harmonious future for all generations.



15/300

PRIORITY ACTIONS

HUMAN RIGHTS, DEMOCRACY AND THE RULE OF LAW

- Promote world peace, international justice and security in neighbouring countries and combat external interference, corruption, human rights abuses, rule of law violations and political repression.
- Protect independent media and ethnic and religious minorities.
- Create a new global alliance for democracy, especially in partnership with major democracies such as the United States, the United Kingdom and Canada.
- Take a firm stance against human rights violations against minorities (e.g. LGBTQ+ people) in third countries, using all possible means of pressure.

COOPERATION WITH PARTNERS

- Play a leading role in the reform of multilateralism, and in particular, call for the reform of the United Nations Security Council to create more multilateral alliances as well as promote dialogue between different cultures and civilisations, strengthen peace, human rights and democracy in the world and promote “soft power”, our values and strategic autonomy.

ROLE OF THE EUROPEAN UNION AS A GLOBAL PLAYER

- Strengthen the role of European Union companies in non-member countries as multipliers of the Union's values while considering the needs of EU SMEs.
- Include these companies in trade agreements.
- Guarantee respect for European Union labour and human rights standards in international trade agreements.
- Combat arms trafficking, with a particular focus on the post-war period in Ukraine.

INTERNAL AND EXTERNAL SECURITY

- Align European migration and asylum policies.
- Improve the protection of the European Union's external borders.
- Deploy a coherent strategy in the fight against “hybrid threats and campaigns” to help European countries counter them effectively.

DEFENCE

- Develop a genuine European military power and support Europe's strategic autonomy while preserving the transatlantic relationship with NATO.
- Strengthen the European Union Military Staff (EUMS) to ensure effective coordination and planning of military operations.
- Encourage joint European procurement of military equipment to achieve economies of scale.



CONSOLIDATION AND AUTONOMY

In the vast field of industry, where our future is forged, we are committed to cultivating a European economy that protects our resources, diversifies our supplies, safeguards our strategic companies and promotes fair competition on a global scale.

Thus, to reduce our dependence on a small group of supplier countries, we will be diversifying our sources of supply and ensuring their security. At the same time, we will institute effective reuse and recycling mechanisms to mitigate the environmental and economic consequences of the extraction of these resources.

In addition, we will pay particular attention to the threat of economic espionage. By implementing advanced surveillance methods and implementing appropriate protection measures, we will strengthen our resilience against this growing threat.

But there can be no autonomy without transport. In this area, as well as adopting new digital and energy technologies, we are committed to investing in an efficient network of high-speed rail, air and sea links. We are convinced that improving infrastructure will facilitate cross-border travel and promote European integration. By developing transport – especially public transport – we will increase trade, encourage intra-European tourism and make it easier for people to get around.

In addition, we will develop simplified and transparent procedures to facilitate access to funding for research and development. By supporting access to EU funds, we will stimulate creativity, encourage the emergence of new ideas and strengthen Europe's competitiveness on the world stage.

In order to create employment opportunities, promote growth and allow Europe to remain at the forefront of technological innovation, we will implement policies and incentives and encourage the transformation of research results into concrete products and services.

Finally, we are convinced that investment in the space sector is essential for Europe's competitiveness, security and prosperity. However, we will promote responsible practices in space exploration and put in place security rules to protect the interests of the EU and its Member States in space.

20/300 PRIORITY ACTIONS

INDUSTRY

- Increase the circularity of materials in the European Union by developing the reuse and recycling of rare materials, with comprehensive supply chain monitoring and promoting eco-design.
- Develop the sustainable exploitation of strategic raw materials in the European Union and further diversify our imports.
- Better control the export of strategic goods and technologies.
- More closely monitor and counter economic espionage by foreign actors.
- Enable fair international competition and support our strategic industries by considering the creation of a European fund to protect strategic industries against coercive practices or takeover attempts from outside the Union.

TRANSPORT

- Demand compliance with the investment plans set out in the Trans-European Transport Networks (TEN-T) to improve cross-border connectivity through a European network of high-speed rail, air and sea links.
- Accelerate the transport sector's digitisation and ecological transition and develop an integrated, smart and European mobility system.
- Support the production of batteries and energy storage in the European Union and the deployment of alternative fuel supply infrastructures.
- Propose the celebration of a European Year of Cycling.
- Make the European Union a leader in zero-emission aircraft.
- Strengthen public transport, particularly by simplifying its use through shared ticketing systems.
- Develop the Single European Sky, a key element in the efficiency of air transport and emissions reduction.

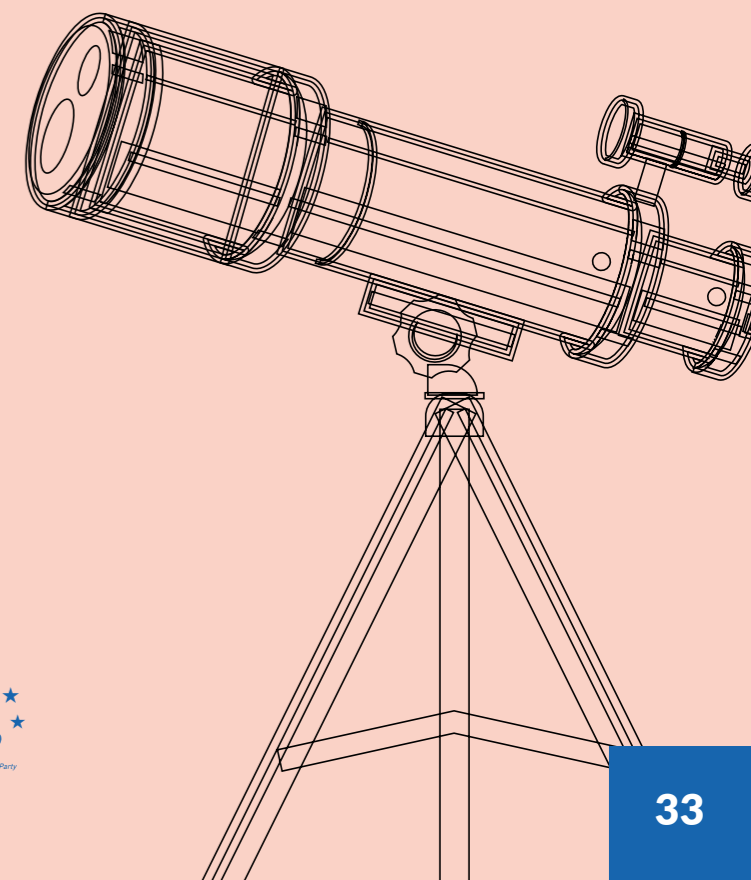

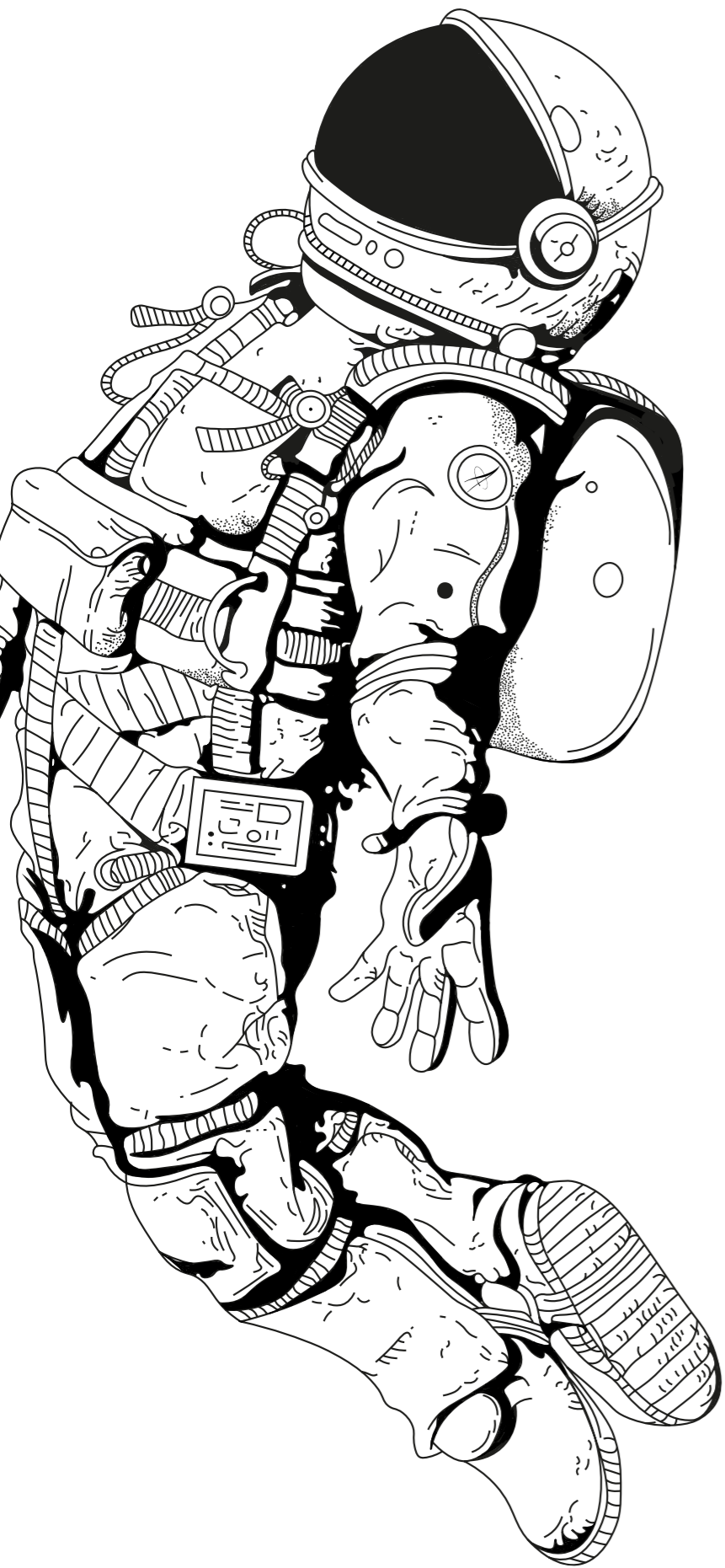

RESEARCH AND INNOVATION

- Simplify access to European Union funds for research and development, particularly for SMEs and researchers.
- Promote the commercialisation and market adoption of new technologies and innovations in the European Union.
- Promote synergies between European programmes.

SPACE

- Propose general European Union legislation for space, including environmental and space sustainability criteria and space security rules.
- Increase the European Union's space budget, mainly to guarantee its access to space and the development of its satellite constellations (Galileo, Copernicus, IRIS 2).
- Propose the creation of a European Space Command to protect better our European space assets and those of the Member States.
- Support the launch of public and commercial satellites from the European Union.
- Revise the Treaties to give the European Union a greater role in regulating space.

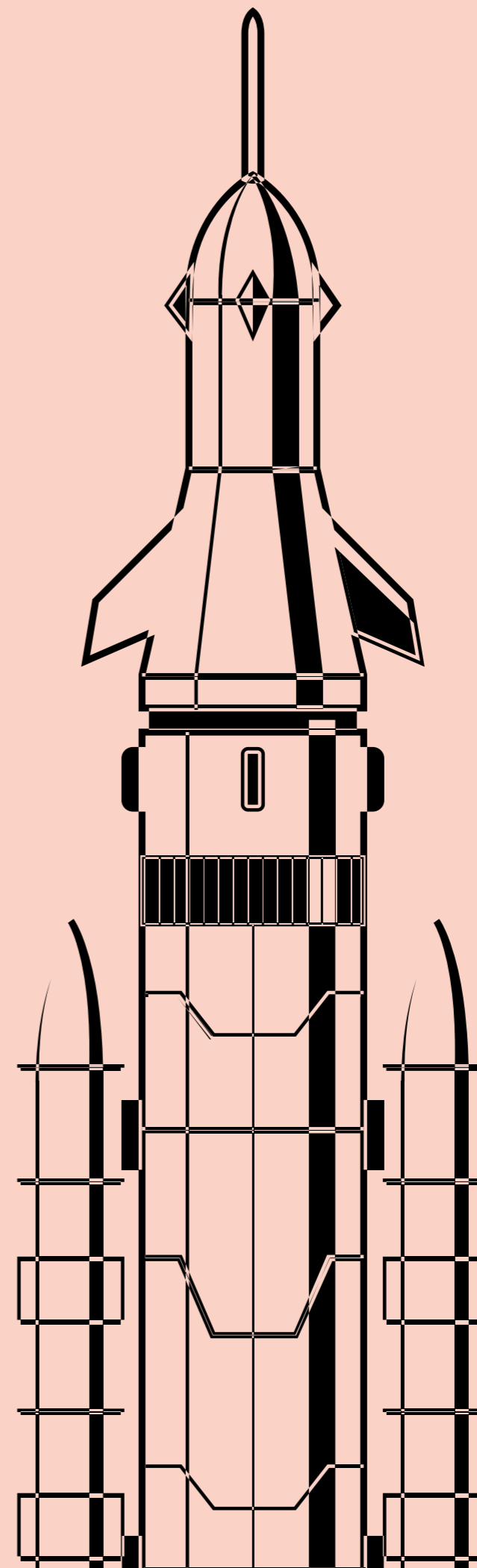

FUNDING COMMON PUBLIC GOODS

It's time to talk about funding. A central question looms: how can we provide the European Union with new own resources to support our collective ambitions?

Although in November 2022 the Parliament gave the green light to the Commission's proposal to introduce a first set of three new own resources (an expanded Emissions Trading Scheme, a Carbon Border Adjustment Mechanism and a share of the reallocated profits of very large multinational companies*), we are looking further ahead.

We are convinced that, in order to revitalise the European economy, it is essential to strengthen direct funding while reducing its dependence on national contributions or taxes levied on citizens. Indeed, citizens must not be taxed by Europe. Instead, large polluting companies and digital giants take advantage of the single market while externalising their activities, which must be held accountable to achieve these objectives.

This approach will allow us to fund new infrastructure, research projects, and the green and digital transitions without excessively burdening any Member State.

The significance of this approach lies in the fact that no Member State can raise funds in isolation. In the face of the challenges that lie ahead, it is not a simple transfer of resources from one country to another that must be imagined, but rather a collective response from the Union. We want to act at the European level, where individual states cannot do so effectively. This is what we mean by subsidiarity.

These new resources will be specifically allocated to projects where the pooling of resources makes the most sense. Our priority will therefore be to support artificial intelligence, invest in tomorrow's economy (especially in the digitisation of industry) and support research into renewable energy and future technologies.

(*) Resources are generated from contributions from the Emissions Trading System (ETS), the Carbon Border Adjustment Mechanism (CBAM), and a share of the residual profits of large multinational companies.

10/300 PRIORITY ACTIONS

OWN RESOURCES

- Develop corporate taxation to align corporate tax bases within the EU.
- Introduce taxation of crypto-currencies, a poorly regulated sector that exploits the different tax regimes applicable between Member States.
- Adopt a tax on digital giants so that all players pay their fair share, as they are taxed at half the rate of traditional European companies.
- Ensure that large multinational companies contribute proportionately to their footprint, particularly those with a significant environmental impact.
- Ensure that these new resources are generated in a fair and transparent manner.

RELAUNCH

- Support new infrastructure and research projects, create jobs, and strengthen global competitiveness.

GREEN, DIGITAL AND KNOWLEDGE TRANSITION

- Allocate a significant share of new own resources to projects related to renewable energies, research on the technologies of the future and the digitisation of industry, culture and Erasmus.

COMPETITIVENESS

- Ensure that the European Union is not placed at a competitive disadvantage.
- Encourage the participation of citizens in the definition of projects financed by these resources, thus guaranteeing a democratic and transparent approach.

UNION OF VALUES

- Strengthen the European Union's ability to finance civil society or local authorities directly when adopting financial sanctions for breaches of the rule of law against a European Union government by promoting smart budgetary cross-compliance and giving the European Union the possibility of providing financing, as proposed by Renew Europe.

COHESION AND EQUITY

We are fully committed to promoting gender equality by ensuring everyone has equal access to education and employment opportunities in key sectors. Investing in developing skills and expertise for all will stimulate innovation and strengthen competitiveness. We also promote the well-being, health and safety of families and their members in our demographically changing society.

Intergeneration is also one of our priorities; we are committed to young people and the elderly. We aspire to build a balanced, resilient society where each individual, regardless of age, can meet future challenges. We firmly believe that the key to sustainable collective prosperity is providing everyone with the necessary means and opportunities.

To achieve this goal, we will implement policies that promote investment in young people. We consider them to be the foundations of our future and are committed to supporting their acquisition of skills, mobility and access to high-quality internships. By investing in the training and development of young people, we will shape a dynamic and skilled generation ready to contribute actively to the prosperity and sustainability of our society.

At the same time, we will develop policies and initiatives for seniors to ensure their well-being, active participation in society and access to continuing opportunities.

By guaranteeing equitable access to quality training, we will enable all individuals to develop their potential and contribute fully to the economy and society.

We also want to create a European Talent Ob-

servatory to promote collaboration between Member States to identify best practices in education, training and skills development.

We are firmly convinced that by encouraging educational innovation, we can ensure that our continent remains at the forefront of education and training.

We believe deeply in a Europe that celebrates diversity. We consider it a strength that must be valued. Strengthening the welfare state and social protection systems to enable them to respond to the demographic, digital and ecological transitions underway will always be at the heart of our commitment.

In the European Union of tomorrow, the individual will be at the heart of the city. We will create fully accessible, barrier-free cities for people with reduced mobility. Families will be recognised and respected throughout Europe, with national laws guaranteeing equality and dignity for all.

We will be at the forefront of promoting equality and respect for all. We will ensure that our European standards, which are already among the most advanced in the world, become increasingly consistent across the Union.



25/300 PRIORITY ACTIONS

FIGHTING FOR GENDER EQUALITY

- Ensure equal pay for men and women.
- Consider equality as a factor of competitiveness by allowing the integration of all available talent into the productive system.
- Fight harassment in the workplace and advance gender equality constantly and relentlessly in all aspects of life.
- Guarantee sexual and reproductive rights throughout the European Union.
- Eradicate all forms of violence against women and children and gender-based violence.

INTERGENERATION

- Extend European legal protection against age discrimination beyond the field of employment.
- Allow older people to benefit from long-term care by strengthening their independence, integration, and societal role.
- Ensure the participation of older people in all areas by promoting a European strategy for active ageing.
- Allow full, affordable and equal access to public services such as public transport and housing.
- Facilitate transition periods between learning, work, family care and periods of unemployment, and allow retirement to take place at different ages.
- Promote human rights throughout life at the United Nations.

QUALITY TRAINING

- Create a European Talent Observatory.
- Allow the export of social security rights to encourage mobility.
- Encourage adequate minimum wages.
- Protect safety at work and ensure health, physical and mental safety.



EQUALITY FOR ALL

- Combat poverty, develop targeted support programmes and, in particular, tackle the issue of child poverty.
- Tackle the issue of decent and affordable housing while eradicating “homelessness”.
- Support households and businesses facing fuel poverty and assistance for building renovation.
- Ensure equal rights for people with disabilities, facilitate their free movement and introduce a European Disability Card.

A NEW WORLD OF WORK

- Protect workers with non-standard status and provide them with social protection regardless of their employment status.
- Recognise a right to disconnect and regulate the practice of remote working.
- Promote the upgrading of workers on the front line and define the essential sectors of the economy more clearly.



DIVERSITY AND INCLUSION

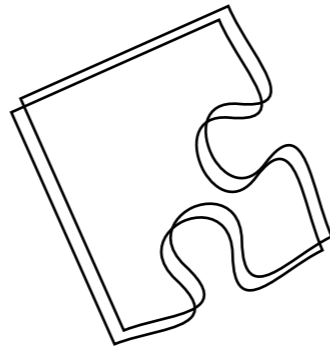

5/300 PRIORITY ACTIONS

We believe in a united, fair and inclusive Europe where everyone is respected and can live fully and freely. We will, therefore, vigorously defend universal human rights rooted in our rich European culture. Our fight will remove all obstacles to an inclusive society, embracing transgender, transgenerational and transnational diversity.

We will actively support diversity and inclusion, defend the rights of minorities and work for the adoption of the horizontal anti-discrimination directive. We will guarantee equality by ensuring the same rights for all families in all countries of the Union.

In addition, we will abolish structural barriers across the continent, ensuring unhindered access for people with reduced mobility. To strengthen our commitment to fundamental rights, we will double the budget and staff of the European Union Agency for Fundamental Rights, thereby expanding its mandate and functions.

- Recognising and upholding universal human rights is an integral part of our European culture, and we will work to remove all obstacles to building a fully inclusive society: transgender, transgenerational and transnational.
- Promote diversity and inclusion, defend respect for minorities and support the adoption of the horizontal anti-discrimination directive, which has been awaited since 2008.
- Ensure that families enjoy the same rights as in their country of origin in all EU countries.
- Promote an ambitious plan to remove structural barriers throughout the Union and thus allow access for people with reduced mobility.
- Strengthen the European Union Agency for Fundamental Rights by doubling its budget and staff and broadening its mandate and functions.

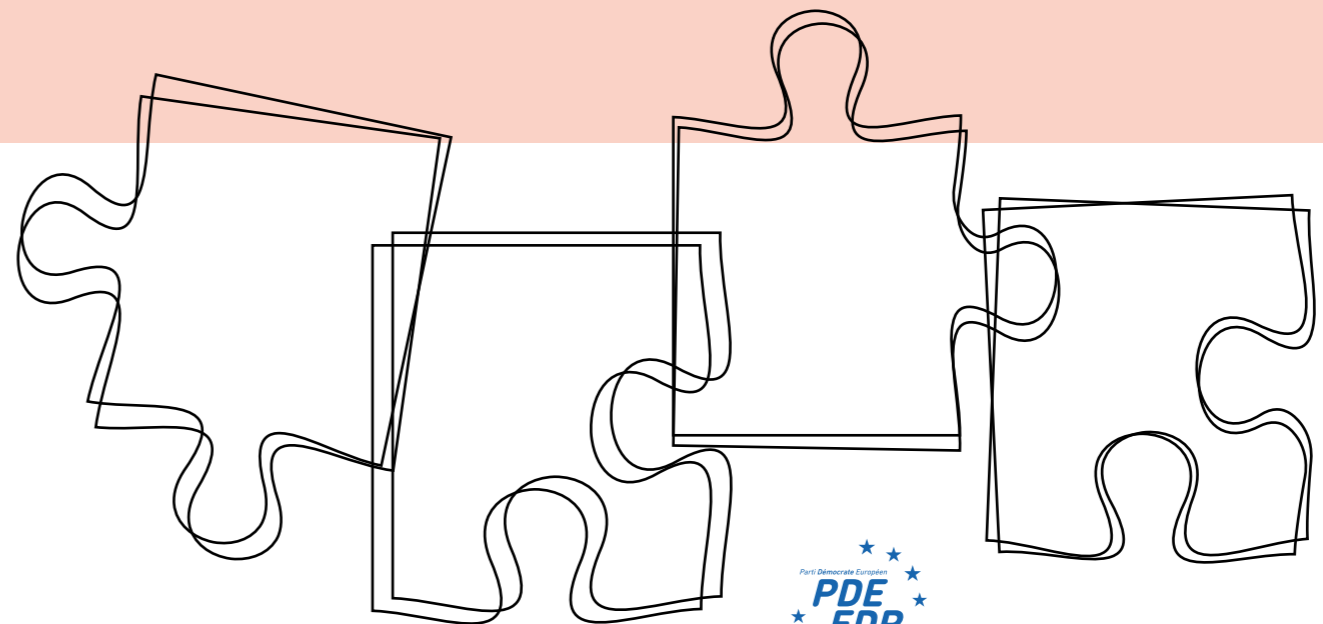
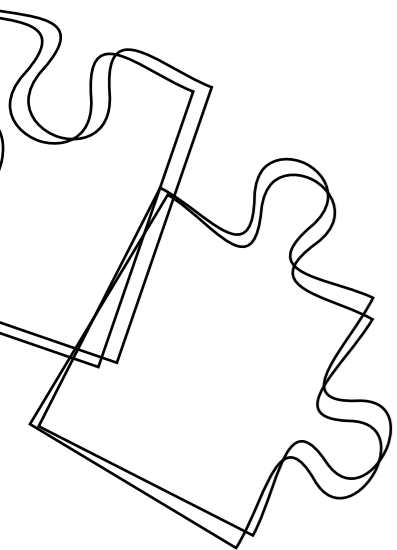

REFORMING THE EUROZONE

In an ever-changing world, reforming the eurozone is a complex issue that requires an ambitious initiative and collective action.

Our proposal is clear: a courageous reform of the eurozone. We are determined to create an economic union that not only withstands crises but becomes even stronger and more prosperous.

In the face of the threat of the return of inflation and low growth on our continent, we are responsible for building a stronger eurozone, an area that resonates with growth and convergence between all member countries and whose operation will be optimised.

The unity of the European Union remains our most valuable asset. Still, knowing that each Member State has unique economic characteristics and needs, we propose a balanced approach that will encourage the development of common standards while taking into account national specificities. This approach will be the key to implementing effective structural reforms, strengthening the capacity of our economies to grow together and withstand turbulence from outside.

Reform also means modernising the eurozone.

We want to create the digital euro while taking care not to eliminate liquidity. This innovation will offer citizens a new payment tool, capitalising on the transformative capacity of digital currencies. This digital euro will not be a replacement for cash but a new method of payment.

While respecting the fundamental principles of confidentiality and convenience of payments, the creation of the digital euro will propel our common currency to the forefront of the 21st century and enable us to retain our monetary sovereignty in the face of other major powers who are also developing their digital currencies.

10/300 PRIORITY ACTIONS



CONVERGENCE TO BECOME STRONGER

- Recognise the importance of country-specific approaches.
- Facilitate harmonious growth throughout the eurozone and strengthen financial stability.
- Encourage investment to achieve key objectives such as the twin green and digital transition and the EU's strategic autonomy.



STRUCTURAL REFORMS

- Work towards a eurozone where economic challenges are tackled collectively and align our budgetary policies.
- Propose a stricter and more transparent adherence to existing budgetary rules.
- Ensure responsible budget management to address disparities in employment, growth and productivity and take better account of climate-related risks.
- Promote equitable economic development throughout the eurozone while encouraging the public investment necessary for a just transition to a carbon-free economy.



COMPLIANCE WITH BUDGETARY RULES AND COOPERATION

- Promote economic cooperation and new joint investments (particularly in digital, ecological and security fields).



DIGITAL EURO

- Introduce our digital currency to retain monetary sovereignty and consolidate the eurozone as a world leader.



PAYMENT METHODS OF THE FUTURE

- Develop digital financial identification across the EU, enabling customers, banks, and investors to easily recognise identification from other EU Member States.
- Push the European Central Bank (ECB) to better monitor large liquid and digital transactions to combat money laundering, tax evasion financing terrorism and organised crime.

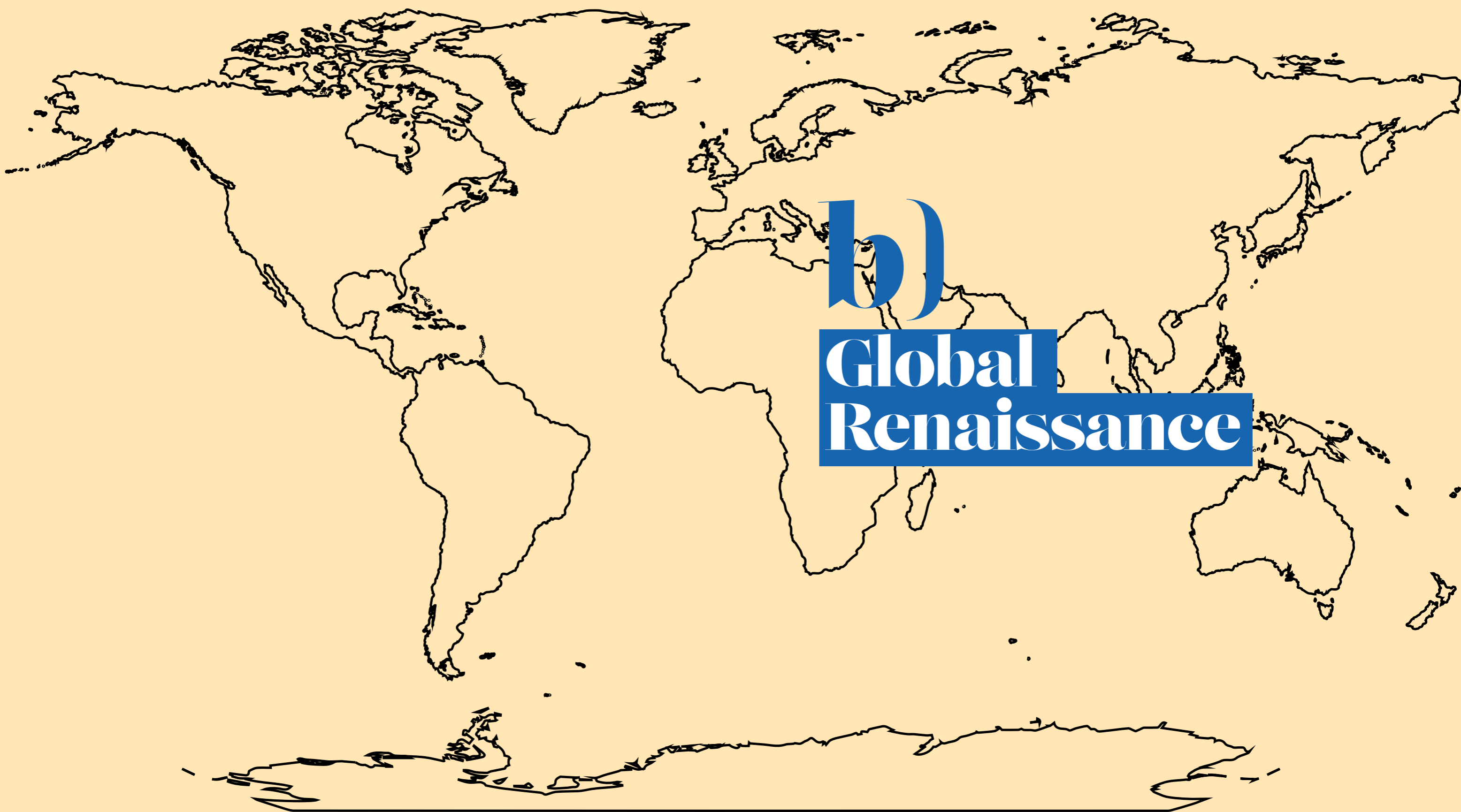

b)
Global Renaissance

Global Renaissance

MIGRATION FLOWS

50

Europe must take a humane approach to migration flows while guaranteeing security and integration. We propose a comprehensive approach based on international cooperation, including creating legal channels for economic migration, the protection of refugees and the fight against the root causes of forced migration.

GREEN AND BLUE LEADERSHIP

54

We are committed to leading the transition to a green and circular economy. Europe must be a world leader in the fight against climate change by investing in renewable energies, promoting sustainable mobility, and supporting environmental research.

ENHANCED HEALTHCARE

58

The pandemic has highlighted the importance of this sector. We propose strengthening European healthcare systems by improving coordination and response to health crises. Europe must invest in medical research, guarantee equitable access to treatment and promote healthy lifestyles for all.

FOOD SOVEREIGNTY

60

We support sustainable agriculture that preserves biodiversity, promotes soil health and guarantees high-quality food. Food sovereignty is essential to reduce external dependency and promote local production that respects the environment. We will also encourage responsible fishing to preserve our marine ecosystems.

DIGITAL REVOLUTION

64

Europe must embrace the digital revolution while protecting individual rights and privacy. We advocate the creation of a digital single market, encouraging technological innovation and digital inclusion for all citizens. Cybersecurity and ethical regulation will be at the heart of our approach.

450 MILLION CONSUMERS

66

Consumer rights must be protected in a competitive and sustainable European market. We promote product transparency, consumer safety and access to clear information. Our commitment to consumer rights will help build trust and encourage fairer business practices.



PRIORITY ACTIONS

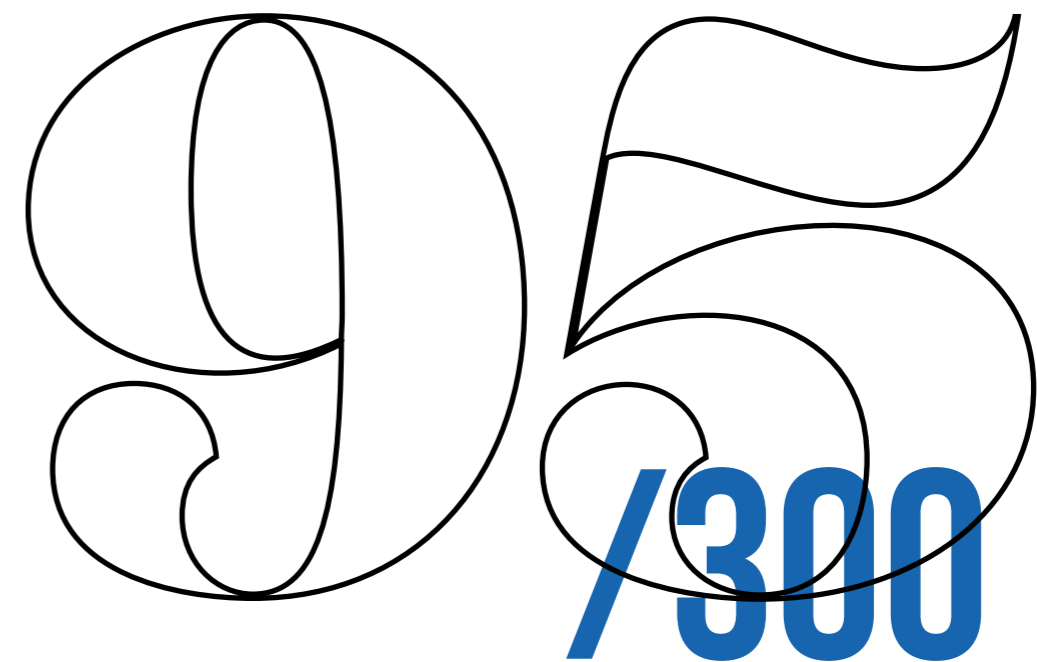

MIGRATION FLOWS

As Europe prepares to face the challenge of population decline, we advocate a strategic and concerted approach to asylum and migration policies between Member States.

While recognising the need to address the challenge of migration by investing wisely in local economies, our commitment to effectively securing our land and sea borders remains an unwavering priority.

In collaboration with local and regional authorities and national and European forces, we will affirm our commitment to the informed management of economic migration. This will result in establishing “European quotas” that will regulate economic flows, thus guaranteeing an orderly arrival of individuals on our continent. At the same time, we will deploy a robust strategy to dismantle criminal networks while saving those in distress at sea.

Human rights and equality lie at the heart of what we do. For every migrant, we will always put social, economic and cultural integration at the forefront. Special attention will be paid to unaccompanied minors and young people who have recently arrived on our continent. To this end, we will mobilise the necessary resources to catalyse integration projects that actively involve them and guide them towards a successful transition to the professional world.

Through these fundamental values, we aim to shape an inclusive Europe rooted in security and deeply respecting human rights. By embracing the dynamics of migration, we are seizing the opportunities to create a strong and diverse Europe.

10/300 PRIORITY ACTIONS



IN SITU DEVELOPMENT

- Develop economic investment programmes in migrants' countries of origin.
- Stimulate economic development and job creation.
- Ensure access to education, vocational training and employment.



BALANCED ECONOMIC MIGRATION POLICIES

- Implement enhanced security measures to prevent and combat illegal immigration.
- Adopt “European quotas” to regulate economic flows and ensure migration is orderly and advantageous.
- Accelerate the processing of return requests to ease the burden on migrants and host countries.
- Establish effective assisted and voluntary return mechanisms to enable migrants to return to their country of origin in safety and dignity.



SOCIAL AND ECONOMIC INTEGRATION

- Implement policies that promote solid social, economic and cultural integration by integrating cities and regions upstream and downstream of migration policy decision-making processes and establishing financial aid mechanisms to respond to humanitarian emergencies. This is where integration takes place, and most services are provided.



VISAS AND DEVELOPMENT COOPERATION

- Use visas to encourage regular migration and improve cooperation with the country of origin.
- Promote cooperation and the development of relations in the field of migration.



While recognising the need to address the challenge of migration by investing wisely in local economies, our commitment to effectively securing our borders remains an unwavering priority.

 **EUROPEAN QUOTAS**

 **ECONOMIC FLOWS**

 **DISMANTLING CRIMINAL NETWORKS**

 **INTEGRATION**



Through these fundamental values, we aim to shape an inclusive Europe rooted in security and deeply respecting

**human
rights**



GREEN AND BLUE LEADERSHIP

To combat climate change effectively, our party will take a pragmatic approach, guided by data rather than ideology, while ensuring that the burden of financing actions does not fall on taxpayers.

One of our priorities is to reduce the EU's energy dependence by developing clean energy production while respecting technological neutrality. We will encourage using renewable energy and nuclear power according to national choices, recognising their crucial role in reducing CO2 emissions. We will ensure an efficient and sustainable energy transition by exploiting all available solutions.

Our commitment will be based on the pillars of solidarity, stability, sustainability and sovereignty. We intend to forge a new proactive dynamic that aligns the fields of ecology and economics. In this spirit, we will adopt a global perspective while acting locally.

Our approach will focus on two key areas: firstly, a clearly defined strategy for the prudent management of our resources, starting with the precious resources of water and our oceans. Secondly, we will roll out ambitious decarbonisation policies, marking our commitment to the energy transition.

We will actively support regional authorities and encourage the widespread establishment of clean energy sources. This will help reduce our dependence on fossil fuels and significantly reduce greenhouse gas emissions.

We will strive to encourage cooperative energy production in areas with high residential density, highlighting energy equity and promoting the adoption of renewable solutions. In the same spirit, we will transform our cities into more welcoming spaces by favouring sus-

tainable modes of transport and facilitating the transition to a circular economy. We will also actively encourage the sorting of waste and the repair of products.

By strengthening regional cooperation and promoting citizen participation, we will exploit new technologies to boost democracy while celebrating diversity and promoting inclusion. Through this, we aim for a positive environmental and societal transformation.

We will also support the research and development of innovative energy technologies, such as osmotic and fusion energy. Enhanced cooperation between EU Member States in the field of energy is also fundamental to ensure the energy security of the entire continent.

We will fully support the improvement of interconnections between national energy grids, promoting the sharing of resources, strengthening flexibility and encouraging solidarity in the event of energy supply disruptions.

15/300 PRIORITY ACTIONS



TRANSITION

- Avoid the burden of payment falling on citizens and small businesses.
- Speed up the renovation of buildings (insulation, heat pumps, smart lighting, etc.).
- Accelerate renewable and nuclear energy (the main source of electrical energy in Europe that does not produce CO2).
- Invest in innovative energy technologies, such as osmotic or fusion energy (particularly ITER).

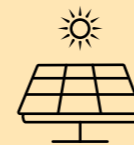

NEW ENERGIES

- Improve interconnections and cooperation between national energy networks to strengthen energy security.
- Consolidate the outermost regions as energy innovation laboratories by exploiting their size, characteristics, and the need to achieve energy resilience through self-sufficiency.
- Promote participatory initiatives for cooperative energy production, particularly in high-density residential areas.
- Involve local communities in the energy transition.



CLIMATE AND THE ENVIRONMENT

- Promote a new European maritime alliance with dedicated funds and ad-hoc technological solutions.
- Strengthen European maritime diplomacy based on the One Ocean Summit in Brest in 2022.
- Involve subnational governments in international climate and biodiversity treaties to ensure effective implementation.
- Emphasise the circular economy through measures such as waste sorting.
- Reduce water waste by improving and repairing infrastructure.



INFRASTRUCTURE

- Expand and improve public transport networks and make public transport the preferred option.
- Help regional and local authorities make themselves more attractive to businesses.

Environment



ENHANCED HEALTHCARE

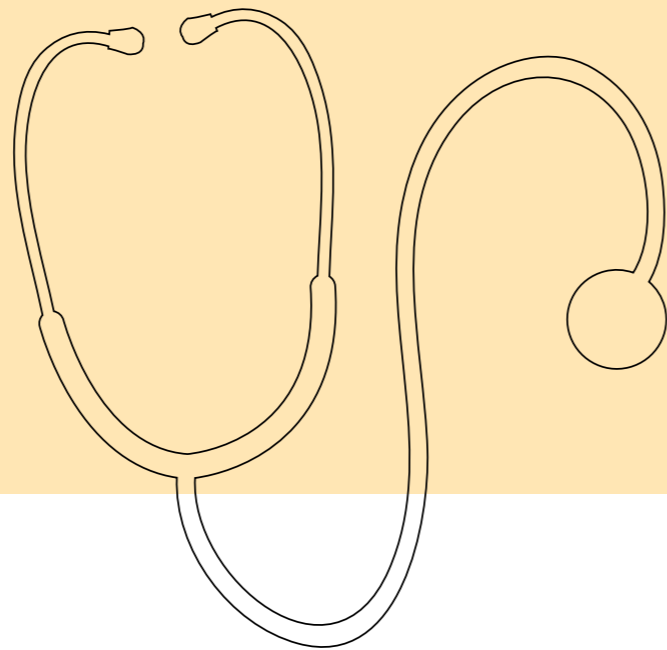

15/300 PRIORITY ACTIONS

In the face of potential health challenges or threats, even though European citizens generally have fairly easy access to a full range of medical services, there's a clear need for enhanced cooperation within the Union. Our future does not lie in independence but in unity.

This vision must be reflected in the seamless coordination of healthcare policies, the constant exchange of crucial information and the establishment of mechanisms for anticipation and instantaneous reaction. The COVID-19 pandemic has highlighted the crucial importance of collaboration between EU Member States to address a global health crisis successfully.

By proposing the strategic relocation of medicines and medical equipment production within the European Union, we will secure the entire supply chain of essential products, thus reducing our dependence on external sources.

By promoting common, comparable and interoperable parameters, we will catalyse the efficient collection and analysis of health data across Europe. We will then be able to monitor epidemics in real time and adjust our public health strategies accordingly.

We want to strengthen the European Centre for Disease Prevention and Control by equipping it with a new capacity to analyse digital data (big data). We would like to dedicate this centre to our late colleague Véronique Trillet-Lenoir, an eminent doctor and respected politician.

However, we will always balance this quest for efficiency with unfailing vigilance in terms of data confidentiality and security. Guided by the highest standards, we will promote cooperation between Member States.

- Strengthen the European Centre for Disease Prevention and Control by equipping it with a new digital data and processing analysis capability.
- Relocate the production of medicines and medical equipment in the EU.
- Create the European Institute of Health to coordinate medical and behavioural research in the various Member States. Its mission should also cover the launch of such activities based on EU funds.
- Encourage Member States to use public-private partnerships in the health sector and facilitate cross-border healthcare to enable their residents to access planned healthcare abroad, particularly by issuing a European Health Insurance Card (EHIC).
- Increase funding and resource allocation to support mental health services, research and initiatives.
- Promote the use of big data in healthcare by promoting common, comparable and interoperable parameters.
- Ensure the highest level of protection for personal data.
- Encourage healthy habits through public health campaigns and initiatives.
- Promote patient-centred care by emphasising the importance of informed consent, shared decision-making and patient autonomy.
- Encourage healthcare providers to involve patients in their treatment plans.
- Ensure that individuals have access to accurate health information.
- Advocate for equal access to healthcare services for LGBTQ+ people.
- Improve mental health outcomes in Member States.
- Prioritise mental health in EU budget planning and distribute funds equitably.
- Introduce prevention into school curricula.
- Work with health professionals, NGOs and pressure groups to strengthen support.

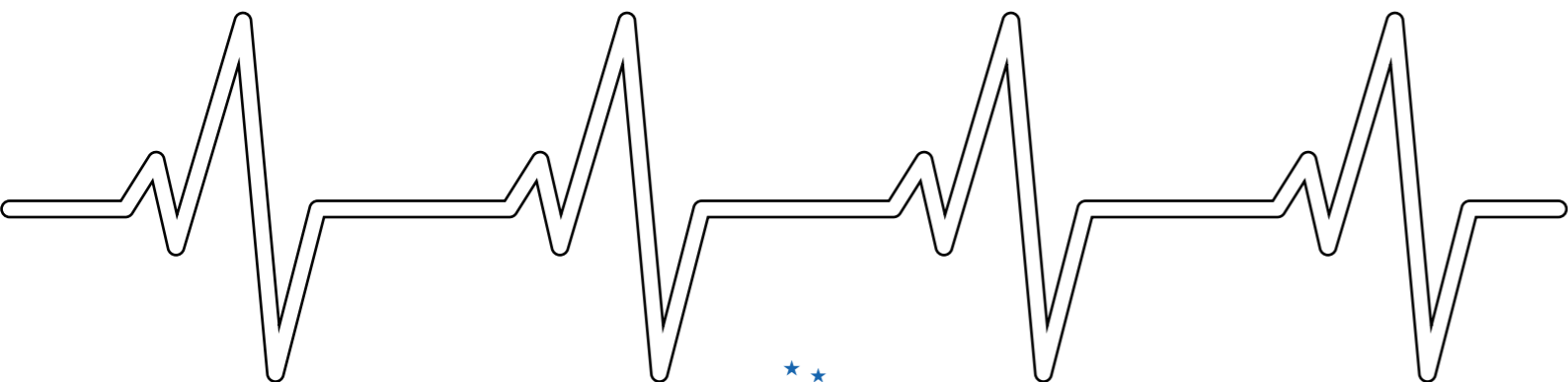

FOOD SOVEREIGNTY

SUSTAINABLE AGRICULTURE AND RESPONSIBLE FISHING

Our priority is finding the right balance between food production and preserving our natural environment, both on land and at sea. We are convinced that these two objectives are interdependent and that we can effectively meet pressing economic and environmental needs by aligning sustainable food production with nature conservation.

We want to adopt an efficient and environmentally friendly agricultural model that is capable of coping with the challenges of climate change and biodiversity loss while guaranteeing the interests of farmers, consumers and rural communities.

To achieve this goal, we propose significant public and private investment in areas such as innovation, digitisation, education and training. We will ensure that these investments, which are cornerstones for strengthening the competitiveness and sustainability of the sector, prosper and guarantee decent living conditions for agriculture and fisheries professionals, as well as a future for the generations to come.

But, in order to preserve our most precious resource, water, we will strengthen the Union's policies by establishing sustainable and effective management. We will promote water-efficient agricultural practices, investment in modern irrigation infrastructure, and establish regulatory mechanisms to avoid waste or depletion of water resources. Proper water management will be a major asset for food security in Europe.

We are determined to embrace digitisation and innovation as the pillars of modern and sustainable agriculture. By supporting the development of advanced agricultural technologies such as precision farming, the use of sensors, artificial intelligence and robotics, we aspire to increase the efficiency of farms and reduce their carbon footprint. This approach will help optimise resources and improve productivity while strengthening farmers' position in the value chain.

We will pay particular attention to fisheries and aquaculture, recognising their fundamental role in food security. We firmly believe that the Common Fisheries Policy plays a key role in ensuring the sustainability of this sector. While highlighting the conservation efforts made over the last decade, we will stress the need to restore the balance between environmental imperatives and the economic and social needs of the sector.

Last but not least, traceability, transparency and a guarantee of the origin and food production methods will be essential pillars of our approach. We are committed to ensuring that consumers can be accurately informed about how food is produced in accordance with the environment and animal welfare.



30/300

PRIORITY ACTIONS

WATER

- Strengthen EU water policies for sustainable and effective management.
- Promote water-efficient agricultural practices.
- Invest in modern irrigation infrastructure.
- Implement regulatory mechanisms to prevent water waste and depletion.
- Contribute to food security.
- Guarantee adequate supplies for agriculture.
- Preserve the environment and water quality.

AGRICULTURE

- Support advanced agricultural technologies such as precision farming, sensors, artificial intelligence and robotics.
- Improve the efficiency of farms.
- Reduce our carbon footprint.
- Optimise the use of resources through digitisation and innovation.
- Create new opportunities for farmers and encourage generational change by considering rural land as a strategic asset and promoting access to land for new farmers.
- Strengthen the position of farmers in the value chain.
- Ensure the resilience of the European food system.
- Take into account local and regional needs.
- Protect soil, animals and biodiversity.
- Reduce food waste.
- Support resilient supply chains and competitive SMEs in rural areas.

FISHING

- Advocate for increased digitisation and traceability of fisheries products.
- Protect the quality of products.
- Ensure fair competition.
- Strengthen sustainable fisheries partnership agreements with third countries.
- Support the external dimension of the Common Fisheries Policy.
- Promote the European fleet's leadership in sustainability with technical and financial support for decarbonisation, digitisation, improved living conditions and regulatory compliance.
- Align the decarbonisation objectives of the Green Deal with the Fisheries and Aquaculture Fund.
- Adapt the Common Fisheries Policy through regionalisation and co-management.
- Prioritise the promotion of sustainable aquaculture and alternative food sources, such as seaweed farming.
- Implement strict controls to prevent the import of unsustainable seafood products.
- Recognise the importance of coastal communities.
- Promote income diversification through environmentally friendly businesses.
- Advocate for the appointment of a specific Commissioner for Fisheries, in line with the importance of the Common Fisheries Policy.



Food Sovereignty



THE DIGITAL REVOLUTION

Digital technology is the cornerstone of Europe's future. In this era of rapid change, it is imperative that we fully seize the unprecedented opportunities offered by the digital revolution.

We will invest in the research, development and implementation of Artificial Intelligence (AI). We must not be afraid of it. On the contrary, thanks to AI, we can unleash an extraordinary potential for stimulating innovation, optimising industrial efficiency and shaping new economic spheres.

In the face of this digital transformation, we are committed to doing everything possible to bridge the generational gap. We are convinced that to build an inclusive digital future, providing a comprehensive digital education that is suitable for everyone is crucial. Training in digital skills is fundamental. We will enable every citizen, whatever their age, to learn and take advantage of the opportunities the digital ecosystem offers. We are therefore committed to simplifying administrative procedures to promote efficiency and encourage innovation for all.

Furthermore, the strengthening of cyberse-

curity will be non-negotiable. Indeed, as we build our digital future, we will further protect our infrastructure, data and online services.

Ensuring the confidentiality and security of our citizens' and businesses' data is a cornerstone for establishing a reliable digital environment. We remain and will continue to remain firmly committed to preserving the utmost respect for fundamental rights and freedoms. We are committed to ensuring that the principles of privacy and freedom of expression are never compromised.

We must also strengthen our ability to ensure reliable supplies for our industries and reduce our dependence on external suppliers. This will strengthen our economic sovereignty while consolidating our position on the world stage.

15/300 PRIORITY ACTIONS

ARTIFICIAL INTELLIGENCE

- Allocate significant resources to the research, development and use of Artificial Intelligence (AI).
- Develop a clear regulatory framework for AI, including transparency and control of algorithms, and promote new governance of artificial intelligence at the United Nations.

DIGITAL INCLUSION

- Invest in comprehensive digital education programmes tailored to all citizens.
- Strengthen the connectivity of rural areas.
- Bridge the gaps between urban and rural areas and facilitate new forms of democratic participation.
- Take greater account of outermost regions.
- Fully defend the rights and needs of seniors.

SIMPLIFY ADMINISTRATIVE PROCEDURES

- Promote efficiency and encourage innovation.
- Remove bureaucratic barriers to facilitate digital access for all.

CYBERSECURITY

- Implement robust protection measures for our online infrastructure, data and services.
- Ensure the confidentiality and security of our citizens' and businesses' data.

SOVEREIGNTY

- Promote a European preference for European digital products and solutions for public administration.
- Increase semiconductor and chip production in the EU through a common strategy.
- Support the storage and processing of data in the EU, in particular to protect it from extraterritorial laws.
- Guarantee a reliable supply.

450 MILLION CONSUMERS

At the heart of Europe's single market, you, the consumers, guide our commitment. We want to create an environment where your rights are protected, and your interests are valued.

We are resolutely committed to implementing the laws adopted and the initiatives launched since 2019 that aim to strike a judicious balance between the responsibilities of companies and the effective safeguarding of consumer rights.

We are convinced that the rapid evolution of technology must not come at the expense of consumer safety and well-being. That is why we will ardently defend the idea that everything considered illegal in the offline world must also be illegal online. Violations of consumer rights, unfair commercial practices and breaches of confidentiality must not find refuge on our continent.

Thus, as the European single market cannot be complete without balanced and consist-

ent online regulation, we are committed to implementing these laws diligently and working closely with companies to understand and respect the responsibilities arising from their digital activities.

Our goal is to create a digital environment where every consumer can buy, sell and have repairs carried out in complete confidence, knowing that their rights and security are protected.

We wish to promote our economic model on a global scale by collaborating with other economies, including the United States and India, while encouraging the creation of a new global digital pact in support of the United Nations.



10/300 PRIORITY ACTIONS

PROMOTE A NEW GLOBAL DIGITAL PACT

- Ensure compliance with digital rules.
- Create an independent body to monitor and verify the interoperability of digital public services while preserving data protection and subsidiarity.
- Encourage durability and reparability, and prohibit planned obsolescence.
- Inform consumers about rights relating to sustainable products and responsible business practices.

DEVELOP A CLEAR FRAMEWORK FOR ONLINE POLITICAL ADVERTISING

- Require the disclosure of sources of funding and targeting methods.
- Introduce severe sanctions for attempts at foreign interference in democratic processes while protecting citizens' privacy.

EVALUATE EACH SECTOR OF THE SINGLE MARKET FOR SECTORAL LEGISLATION

- Establish consultation mechanisms with industry players and stakeholders to draw up rules tailored to each sector.

MEASURE CYBERSECURITY

- Strengthen the NIS Directive (Network and Information Systems Directive) by organising regular evaluations of critical information systems.
- Work with digital service providers to ensure the security and confidentiality of consumer data.
- Establish a cybersecurity incident reporting platform to ensure a rapid, coordinated response in the event of a threat.



Consumers



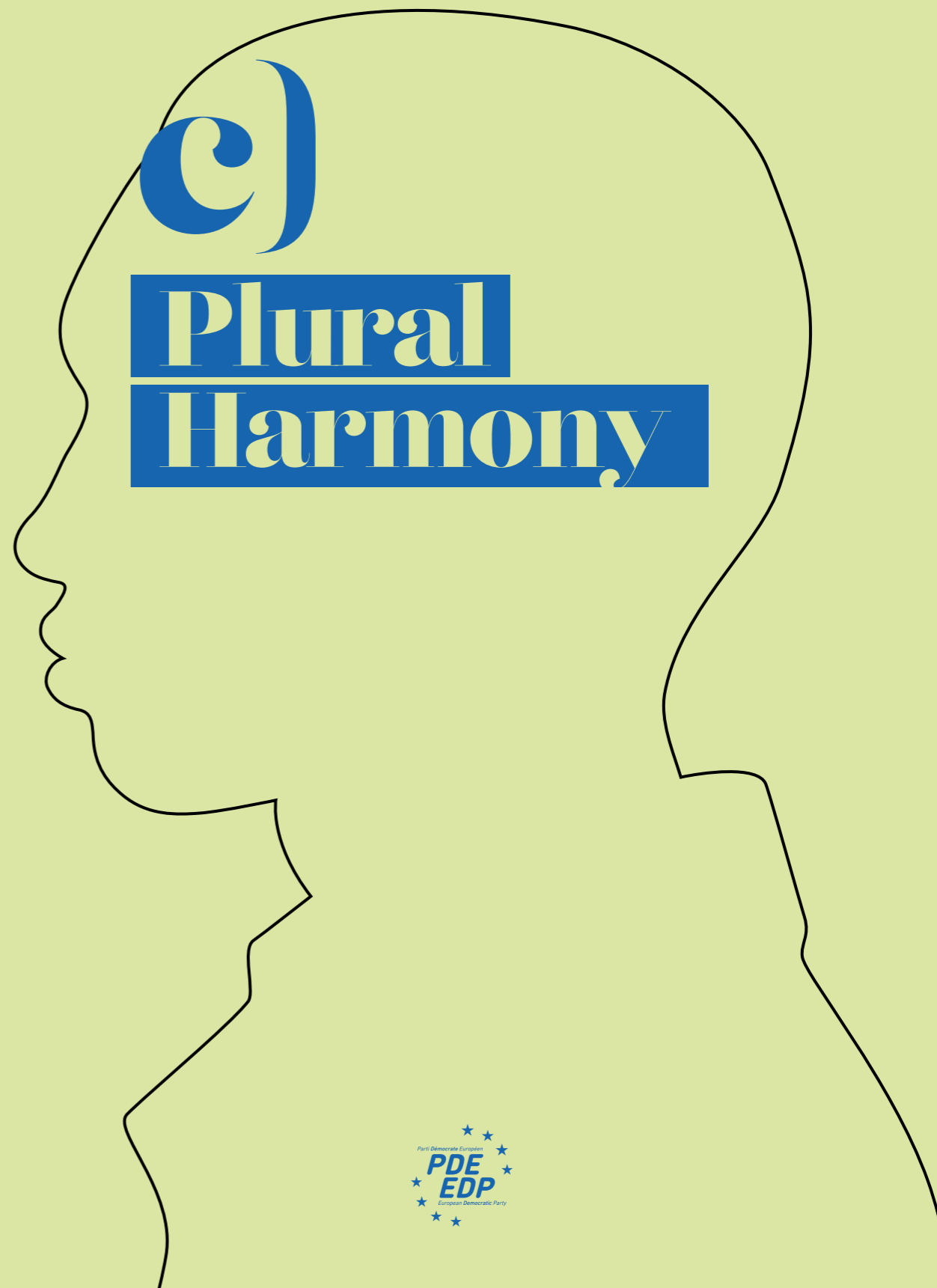
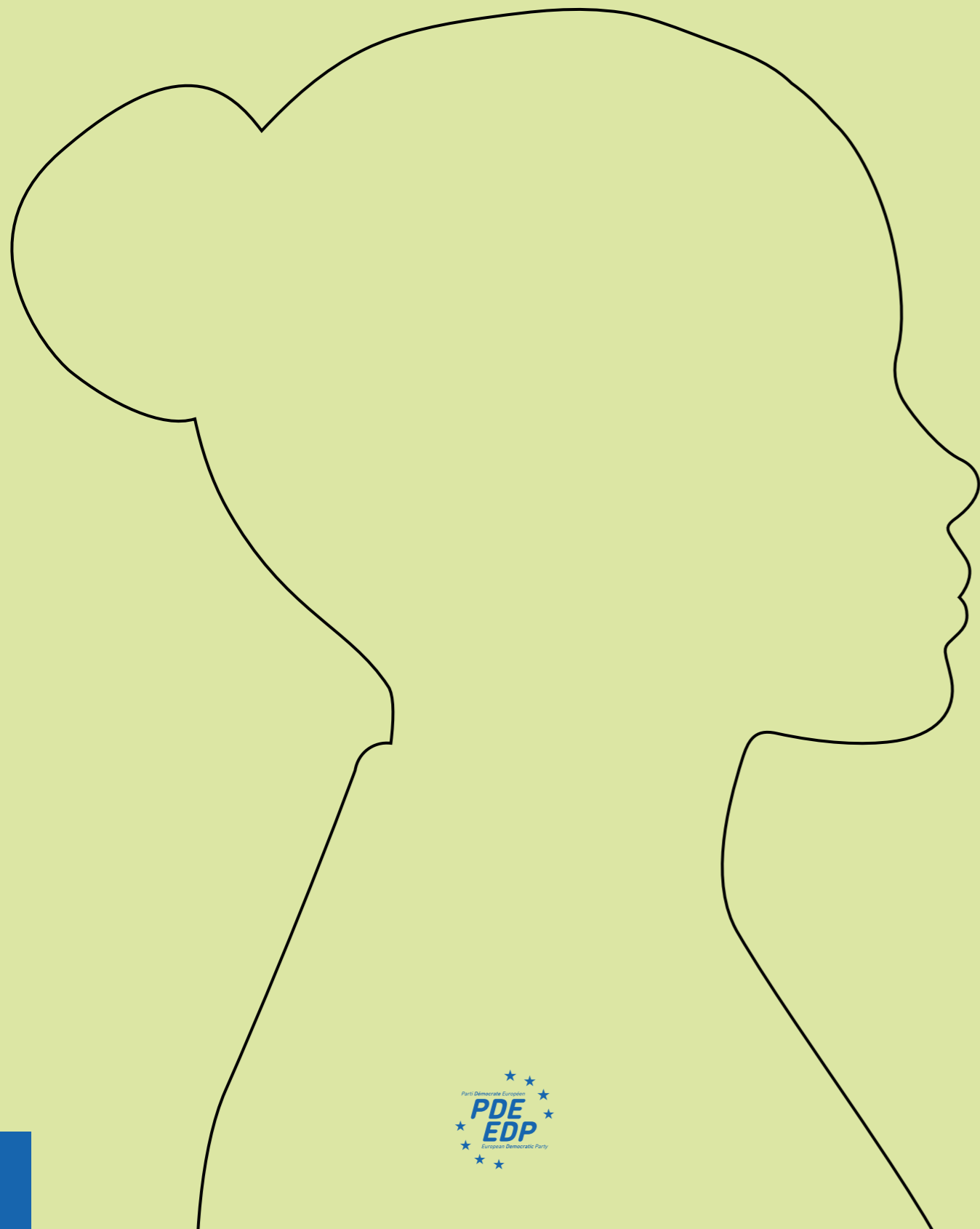

c)
**Plural
Harmony**



Plural Harmony

EQUITABLE GROWTH 74

We are aiming for economic growth that leaves no one behind. We will invest in sustainable and innovative projects to reduce social and economic inequalities while preserving the environment.

THE FUTURE OF YOUTH 76

We are committed to providing opportunities for young people to thrive by investing in innovative educational programmes and facilitating their active participation in decision-making.

QUALITY EDUCATION FOR ALL 80

Education is an essential pillar of an enlightened and prosperous society. Our movement seeks to ensure equitable access to high-quality education across Europe by improving education systems and supporting lifelong learning.

CULTURAL WEALTH AND DIVERSITY 82

Cultural diversity is celebrated and preserved as a source of strength. Our party will encourage cultural exchanges and support artistic initiatives to foster an environment where everyone can flourish while contributing to collective wealth.

MEDIA AND PLURALISM 84

Democracy relies on a free and diverse media. We will defend the independence of the media and continue to fight disinformation, supporting quality journalism and guaranteeing access to balanced information for all.

SPORT AND ETHICS 86

The value of sport is recognised as a catalyst for unity, health and inspiration. We will encourage access to sport for all, invest in quality sports facilities and support athletes, creating a space where everyone can participate and celebrate the values of fair play.



/300
PRIORITY ACTIONS

EQUITABLE GROWTH

We recognise the importance of small and medium-sized enterprises (SMEs) in the European economy, and we obviously wish to support them in their growth and development. We will also implement policies to encourage innovation, simplify administrative procedures and facilitate access to funding.

SMEs must be supported by financing opportunities to stimulate economic growth and foster innovation, and local and regional economies will be strengthened.

The protection of workers and economic stability are also priorities, including aligning social security systems to facilitate the mobility of workers and a more flexible labour market.

We also want to highlight the diversification of production chains, corporate social responsibility, the digitisation of the economy and a truly unified European market for goods and services.

We will encourage a responsible fiscal policy while supporting investments in key sectors, the creation of quality jobs, and construction of a long-term sustainable economy.

10/300 PRIORITY ACTIONS

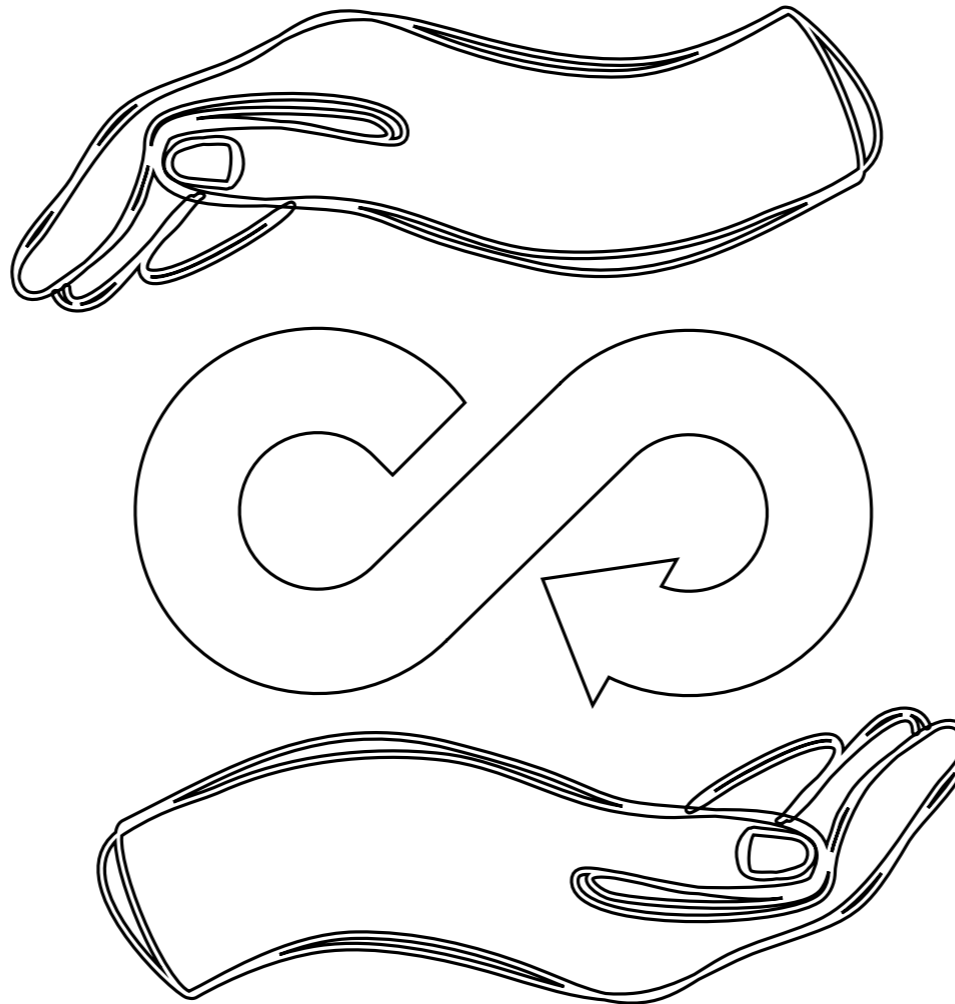

PROMOTE A CIRCULAR AND VIRTUOUS ECONOMY

- Put in place policies that encourage innovation, improve sales markets, simplify administrative procedures, support participation in tenders and projects for SMEs and promote access to funding.
- Support the diversification of production chains and corporate social responsibility.
- Encourage fair and sustainable business practices.
- Create a truly unified European market for goods and services.
- Guarantee worker protection and tax fairness.

A RESILIENT AND SUSTAINABLE BANKING SECTOR

- Support for SMEs is at the heart of the European economy.
- Provide funding opportunities to stimulate economic growth and encourage innovation.
- Strengthen local and regional economies by supporting regional banks.
- Avoid monopoly structures in the banking sector.

THE FUTURE OF YOUTH

10/300 PRIORITY ACTIONS

We are convinced that every young person should have the means to succeed and achieve their potential without being hampered by social, economic or geographical obstacles. Hence why we propose a tangible and effective youth policy for the EU which will provide them with a solid foundation, for example in education, business creation and housing.

We are convinced that young people should have access to high-level education that is open to the world, that rivals the greatest American and Asian universities, and that prepares them for jobs in the labour market. We will be committed to offering young people a European civic education, allowing them to feel like fully European citizens and engage in the democratic process.

We are convinced that young people should be heard in the democratic process and be able to present their visions and ideas.

Finally, we believe that the mobility of young people must be an integral part of all curricula, from secondary to higher education, and that their diplomas and qualifications must be automatically recognised.

Our party is also concerned about the mental health of young people, particularly in view of the omnipresence of social networks, and we plan to introduce concrete measures to protect them. Thus, to preserve and develop these healthy minds, we propose creating a "StartEU" programme that would provide them with the financial and logistical resour-

ces necessary to carry out their projects.

We also believe that civic engagement is important for young people, and we propose creating a European civic service to enable them to contribute to projects of public interest in different European countries and strengthen their sense of belonging to Europe.

Finally, to strengthen their sense of belonging to Europe and promote mutual understanding, we will offer young people more rail travel in Europe, mobility in general and access to cultural activities.

Naturally, our movement will continue to make it easier for young people to access internships and job opportunities within European institutions. This will help develop their professional skills and understanding of the European Union's inner workings.



DIGITAL

- Increase mental health protection among young people, particularly with regard to social networks.
- Define a legal digital age and set up a European mental health hotline to ensure rapid treatment.
- Introduce automatic parental controls to protect young people from inappropriate content on the internet.

TOOLS FOR YOUNG PEOPLE

- Create a "StartEU" programme to give young people a good start in life.
- Provide the financial and logistical resources to carry out their studies, set up a business or find a home.

EUROPEAN CIVIC SERVICE

- Enable young people to gain experience and develop skills while contributing to projects that benefit society.
- Encourage European volunteering, with a particular emphasis on the European Solidarity Corps, which encourages exchanges and promotes the Union's social model and values.

RAIL TRAVEL IN EUROPE

- Help young people to discover other cultures and connect with people from different countries, strengthen the sense of European belonging and foster mutual understanding.

ACCESS TO INTERNSHIPS AND EMPLOYMENT OPPORTUNITIES

- Give young people the opportunity to develop professional skills in an international environment and better understand how the EU works.
- Prohibit unpaid internships and guarantee quality internships for young people, paying particular attention to people from disadvantaged backgrounds.
- Consider alleviating income tax for employees under the age of 25.





Youth

QUALITY EDUCATION FOR ALL

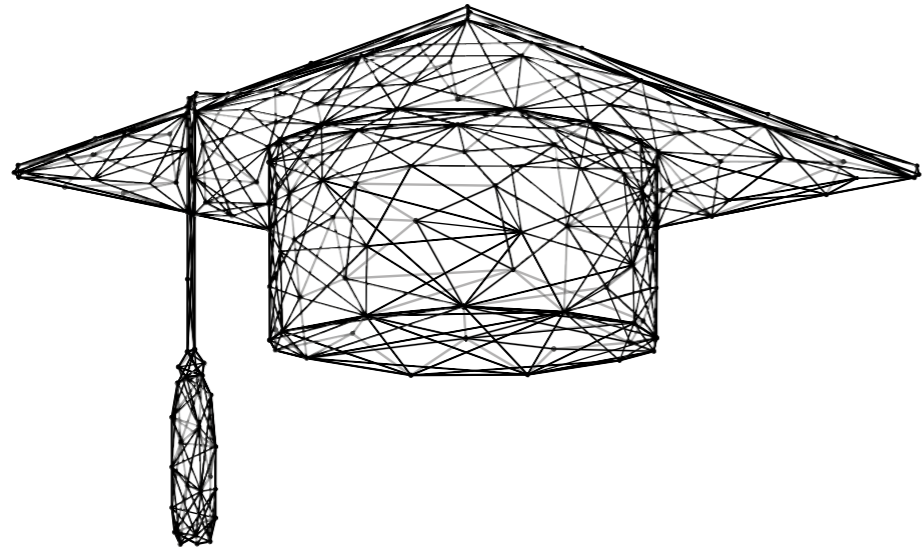

Quality education for all is at the heart of our priorities. We also plan to significantly increase funding for the Erasmus+ programme dedicated to young people in apprenticeships or vocational training, multiplying it tenfold. This aims to cultivate a sense of belonging to Europe while helping young people develop their skills, gain valuable experience, and broaden their horizons.

To this end, we will increase the budget allocated to the Erasmus+ programme tenfold for young people in apprenticeships or vocational training to help them develop their skills, experience and open-mindedness.

We are also firmly convinced that we must increase the representation of girls and women in scientific studies and careers. We will develop mentoring and awareness-raising programmes and build real professional networks.

At the same time, given the demands of the ecological transition, we believe investing in lifelong learning, retraining, and professional reorientation is vital. We must help all those working in sectors undergoing rapid change,

such as the automotive or fossil fuel industries, to retrain. We can certainly achieve this by working closely with employers, workers' organisations and governments.

We will do everything to ensure that diplomas and qualifications are recognised in EU countries, and we will facilitate the mobility of students and workers.

Finally, we will develop cross-border cooperation in education and training to meet labour needs in critical sectors (healthcare, tourism, industry, etc.). By doing so, we can tackle the labour market challenges and ensure we have enough skilled workers to support Europe's future.

10/300 PRIORITY ACTIONS



- Multiply Erasmus+ resources tenfold.
- Develop a strategy of excellence and innovation for European university alliances.
- Fight «brain drain».
- Transform certain professions to meet the demands of the ecological transition.
- Introduce shared skills for European citizenship education.
- Strengthen the sense of belonging to Europe.
- Create a mechanism for the recognition of diplomas and qualifications common to the countries of the European Union.
- Facilitate the mobility of students and workers and encourage the circulation of skills and talent throughout the EU.
- Develop cross-border cooperation in education and training.
- Promote a European strategy for vocational training that includes the principles of predictivity and connection with productive sectors to prepare specialists for the new jobs associated with digital and green transitions.

CULTURAL WEALTH AND DIVERSITY

In the face of the rise of extremism and cultural isolationism, phenomena that threaten the social cohesion of the European Union, we will invest in promoting cultural and artistic diversity, supporting European artists, preserving European cultural heritage and encouraging talent.

Multilingualism will be at the heart of our vision for Europe (*), and we are determined to ensure it has enough financial support. We will promote cultural and linguistic diversity to ensure an inclusive society. This will include support for minority languages and stimulating cultural and artistic cooperation between nations within the European Union.

And although the budget devoted to culture currently represents only 0.2% of the European budget, we hope to multiply this figure by 10.

We will also create a European statute for artists guaranteeing them recognition, mobility and access to social rights. We are convinced that a European strategy to protect strategic cultural assets can preserve Europe's cultural heritage for future generations.

We will implement a European cultural passport to give all young Europeans access to free or discounted cultural assets throughout Europe. By developing a strategy for protecting and enhancing regional heritage, we want to preserve local traditions and strengthen social cohesion.

Finally, we will develop a dynamic strategy for European video games and consolidate the recognition of sports at the professional and amateur levels. This approach should nurture and stimulate European talent while promoting collective values such as team spirit and sports ethics.

15/300 PRIORITY ACTIONS

- Multiply the budget allocated to culture by 10.
- Standardise multilingualism in the communication of European institutions.
- Ensure that all official digital content complies with a regulatory obligation to respect multilingualism.
- Promote agreements with major technology companies so that search engines, algorithms and browsers do not discriminate based on language when users in minority languages make queries.
- Promote linguistic diversity, especially regional languages.
- Support minority languages.
- Include in the eligible actions of the Creative Europe Programme and the pro-digitalisation initiatives of the recovery and resilience plan support for the development of all types of platforms for the production, grouping and dissemination of content in minority or regional languages that contribute to the strengthening and development of a digital identity for these cultures. Ensure their presence on major content platforms.
- Ensure sufficient funding for regional language translations as part of Creative Europe.
- Create a framework for a European status for artists and guarantee recognition, mobility and access to social rights.
- Preserve the sustainability of all artistic and cultural expressions.
- Protect our heritage and strategic cultural assets.
- Prevent the takeover of our major players.
- Strengthen European cultural identity.
- Offer a European passport and give access to free or discounted European cultural assets and shows.
- Promote the cultural mobility of young Europeans.

(*) Report by Christian Lequesne entitled "Diversité Linguistique et langue française dans les institutions européennes (Linguistic Diversity and the French Language in the European Institutions)" (2021).

MEDIA AND PLURALISM

In a growing political and economic pressure climate, we believe that all citizens should have access to free and independent information. Freedom of the press is essential to any democratic society.

To ensure a more balanced and democratic media environment, we are committed to monitoring media mergers and acquisitions, protecting media diversity and strengthening media transparency in accordance with the European Media Freedom Act.

With the advent of social networks and online media, we will strengthen citizens' civic education and media skills to help them develop critical thinking.

Recognizing that the digital transition can lead to abuse and discrimination, we are committed to adapting regulations to protect personal data, combat cybercrime better and ensure equal access to digital technologies for all.

We want to continue fighting against disinformation and false information online to ensure that European values and democratic systems are protected.

10/300 PRIORITY ACTIONS



ENSURING FREEDOM AND PLURALISM

- Protect journalists against any form of intimidation or violence. In addition, denouncing and combating job insecurity in the sector are two main tools to limit freedom of expression.
- Promote media diversity and freedom and respect for press freedom, which are key elements of any democratic society.
- Avoid excessive concentrations and monopolistic practices in accordance with the European Media Freedom Act.
- Guarantee citizens access to free and independent information. Protect the independence of public media services.
- Apply the Strengthened Code of Practice on Disinformation – a wide range of players have signed up to combat disinformation.



CIVIC EDUCATION AND MEDIA SKILLS

- Enable citizens to understand the issues related to the media and to develop critical thinking.
- Educate fellow citizens so that they can discern facts from fiction, and recognise fake news on social networks.
- Ensure equal access to digital technologies for all.



SUPPORT FOR LOCAL, REGIONAL AND EUROPEAN PRESS

- Encourage the digitisation of newspapers and greater coverage of European issues.
- Promote European and cross-border media, such as ARTE.

SPORT AND ETHICS

The importance of grassroots sport in European society is at the heart of our vision. We consider the development of sport for young people as a cornerstone, but we will also pay particular attention to seniors. We aim to create an environment that is respectful, inclusive and conducive to health for all our fellow citizens, regardless of their origin, age or physical condition. This will not only help to promote the physical and mental health of everyone but also strengthen the social fabric of our communities.

We will focus on creating spaces for integration and equity. How do we aim to achieve this in practice? By ensuring access to suitable equipment and developing specific programmes that meet individual needs. This approach will be based on our conviction that equal opportunities must be a concrete and non-negotiable reality in the Europe we are building.

The well-being of young people are at the heart of our concerns; we are committed to promoting healthy lifestyles. Our varied range of physical activities and our wider dissemination of knowledge on the impact of nutrition, sleep and hygiene will be concrete steps in raising awareness of the importance of physical and mental well-being from a young age.

Our actions will also be inspired by fundamental ethical values. Through enriching educational programmes and awareness-raising initiatives, we will encourage loyalty, respect,

honesty and solidarity. These values are not merely concepts but concrete elements that will frame our efforts for a fulfilled and dynamic youth.

Finally, collaboration and mutual respect will be the central pillars of a united Europe we want to build. We will work collectively to refine the social skills of young people through group activities, competitions and events. We are convinced this will strengthen interpersonal ties and create the outlines of a united and cohesive Europe.

By redoubling our efforts and embracing this approach, we will shape the new face of Europe. This face will reflect our commitment to youth, equality, vitality and values.

10/300 PRIORITY ACTIONS

- Promote participation in sport for all young people, regardless of origin or physical ability.
- Multiply opportunities for all and strengthen social integration.
- Offer suitable equipment with specific programmes for particular needs.
- Integrate educational programmes to promote ethical values such as loyalty, respect, honesty and solidarity.
- Raise awareness of social and environmental issues through educational initiatives.
- Define and promote a European model of sport and add European flags and national flags at international European competitions, including the Olympic Games in France this year.
- Ensure respect for the fundamental freedoms and principles of the EU, particularly equality, in professional sport and promote the development of women's competitions.
- Develop a strategy for European video games.
- Contribute to the development of a European creative economy and the promotion of e-sports.
- Promote new governance for European football and reform of UEFA.

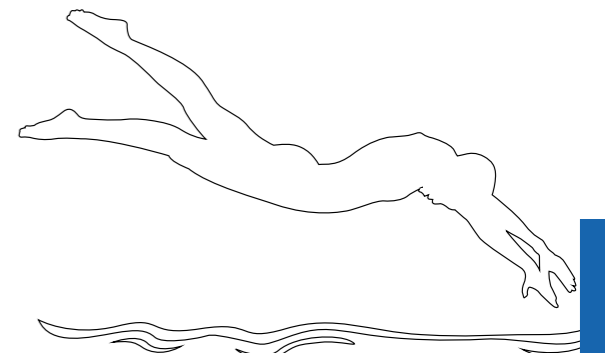
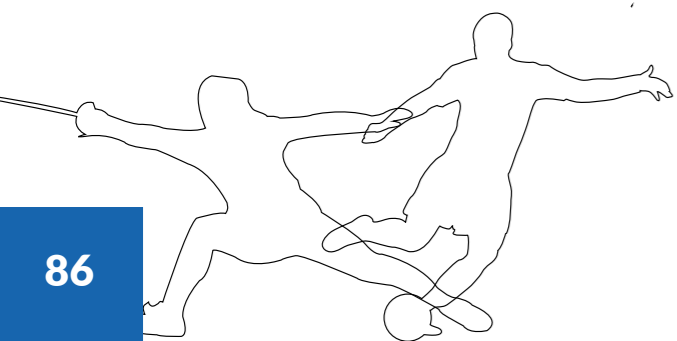



d)

**Vibrant
Regions**

Vibrant Regions

REGIONAL PROGRESS AND PROSPERITY 92

Our regional investments will strengthen economic, social and cohesion in Europe. We will prioritise the fundamental objectives of this policy: reduce disparities between regions, promote balanced economic growth and eliminate obstacles to cross-border regional cooperation.

THRIVING OUTERMOST REGIONS 94

We will support innovation, entrepreneurship, and sustainability in Outermost regions while simplifying administrative procedures and improving connectivity to strengthen their economic development and improve the quality of life of their inhabitants..



PRIORITY ACTIONS

35 /300



REGIONAL PROGRESS AND PROSPERITY

The European Union's Cohesion Policy is a powerful and fundamental tool for combating regional disparities. Through our regional investment strategy, we want to strengthen economic, social and regional cohesion across Europe.

Our commitment has already been reflected in creating a network of European democratic mayors. And, thanks to the "EU Councillors" network that our Renew Europe group supports within the Committee of the Regions, we will continue to mobilise our efforts to bring Europe closer to its citizens.

To speed up this cohesion policy, we will be focusing on three key objectives:

- Remove obstacles to cross-border cooperation
- Reduce regional disparities
- Promote harmonious economic growth

Today, 150 million cross-border citizens reside within the European Union's borders and face daily bureaucratic obstacles that limit their ability to take full advantage of the EU's opportunities for development and cooperation. We will therefore fully support the BRIDGE-EU (Border Regency Initiative for Development and Growth in Europe) programme.

With this in mind, our approach will consist of supporting regional initiatives to combat climate change and preserve our environment. We will provide local councillors with the means to create user-friendly spaces in cities and villages. Our approach will include, for example, promoting pedestrian areas, increasing bicycle sharing and developing cycle paths to bring communities closer together.

Expanding and improving public transport networks in urban, rural and outermost areas will also be essential. We will work to improve intermodality to facilitate cross-border travel. By developing efficient and well-connected transport infrastructure, we will simplify citizens' journeys and promote economic integration. This approach will facilitate exchanges, strengthen trade relations and support tourism development.

The Committee of the Regions needs the necessary resources to develop from a simple advisory body to a communicative player. We want it to become capable of assessing the regional impact of European legislation on the regions and supporting EU legislators in applying the "do no harm to EU cohesion" principle.

Our commitment will also include simplifying the EU funding process by reducing bureaucracy to enable regional and local authorities to quickly implement sustainable projects such as digital infrastructure, public spaces and economic development initiatives.



10/300 PRIORITY ACTIONS

OPPORTUNITIES

- Implement the BRIDGE-EU (Border Regency Initiative for Development and Growth in Europe) programme and promote macro-regions.
- Encourage the exchange of local good practices at the European Union level, provide concrete evidence to European Union decision-makers, and use artificial intelligence to facilitate access to European funds.
- Support the development of the European Committee of the Regions' "EU Councillors" network, which can help strengthen the connection between the Union and its citizens.

INFRASTRUCTURE

- Improve intermodality to facilitate cross-border travel, and introduce in the Revision of the Schengen Borders Code the obligation for States to carry out and examine impact studies on trade and relations in cross-border areas before taking any decision on the reintroduction of controls.
- Defend the mission of Cohesion Policy to ensure that it is not jeopardised by the redirection of funds to crisis management.
- Facilitate regional and local authorities' access to European Union funding by, for example, reducing or eliminating national bureaucracy in the EU funding process.

ENERGY

- Support regional authorities with the expansion of renewable energy.
- Promote participatory initiatives for cooperative energy production.

CLIMATE AND THE ENVIRONMENT

- Increase the number of car-free streets and push for other measures to make cities and villages more people-friendly, such as bike-sharing systems, pavements and cycle lanes, and lower speed limits.

DIGITALISATION

- Invest in the digital transformation of regional and local public administrations, allowing public services to be retained in rural areas.



THRIVING OUTERMOST REGIONS

The green transition offers an unprecedented development opportunity for the outermost regions, and we are convinced that they have immense potential to become innovation hubs.

We believe it is essential to develop a strong entrepreneurial dynamic by encouraging the creation of companies, supporting local entrepreneurs and promoting innovation. For example, in Mayotte, where the unemployment rate is as high as 30%, one of the highest in Europe, we want the region to be on a course of endogenous development and do everything we can to stimulate the economy.

In addition, we will invest in local production to develop agricultural practices that respect the environment. The outermost regions will thus strengthen their food security and reduce their dependence on imports.

Tourism is, of course, an essential sector for the outermost regions. We will support its development with, once again, innovative, sustainable and durable investments.

We are committed to supporting the economic development of the outermost regions by maximising the impact of European funds and programmes while meeting the specific needs of each region.

We want to strengthen the economies of the outermost regions and improve the quality of life of their inhabitants. To achieve this, we propose simplifying administrative procedures,

strengthening the managing authorities' skills, and promoting better coordination between the various players involved. In addition, we will put forward measures to make European citizenship a reality by strengthening education and encouraging regional integration.

Because the future of the European Union lies with its young people, we will be mustering all available resources to promote training, mobility and, therefore, the emancipation of the outermost regions. By applying the European strategy to combat brain drain, these young people will be ready to take on future challenges and play their part in the development of the outermost regions. Of course, to promote connectivity and digital development, we will support constructing a high-speed internet network.

Lastly, we will propose solutions for fair representation of the outermost regions within the Committee of the Regions to ensure that their interests and concerns are fully considered in European decision-making.



25/300 PRIORITY ACTIONS

ECONOMY

- Develop the entrepreneurial dynamic in the outermost regions by mobilising the available European funds and programmes, particularly the European Social Fund (ESF+).
- Achieve autonomy in terms of food self-sufficiency.
- Set up social free-trade zones throughout the outermost regions to boost purchasing power, combat unemployment, encourage recruitment and develop skills.
- Regulate air transport with agreements on intra-Community airport taxes for European carriers to reduce consumer fares and strengthen European territorial continuity with direct links to other European countries.
- Raise awareness of and develop schemes that provide funding for young Europeans to set up new businesses in specific areas of local development.
- Establish more flexible state aid schemes for outermost regions, particularly in the agricultural and territorial continuity and energy transition sectors.
- Develop tourism with innovative, sustainable and durable investments to support the sustainable development of this strategic sector for the outermost regions.

GREEN TRANSITION

- Turn outermost regions into climate solutions testing grounds, drawing on their expertise in dealing with climate change, their rich biodiversity and their resources.
- Create an Energy Performance Diagnostic adapted to outermost regions and develop renewable energy solutions adapted to each outermost region (solar, geothermal, biomass, tidal power, wind, etc.).
- Protect research using soil species with patents. The species are endemic, and the patents will generate local financial benefits, attracting new investments and giving European laboratories priority access to their patents.
- Take outermost regions into account when implementing the European Union Solidarity Fund to fund risk prevention measures in the face of natural disasters and promote the exchange of knowledge between outermost regions and their regional neighbours.
- Raise awareness of the "EU Cities" mission to promote collaboration, through the exchange of good practices and twinning, between the cities of the outermost regions to develop the "Smart Cities" network by 2033.
- Promote education programmes on the European Union's green skills to raise awareness of the value and impact of sustainable choices for the economic development of the regions.



USE OF EUROPEAN FUNDS

- Ensure the full use of European funds, strengthen the relationship between project leaders and fund managers and simplify the procedures for European funds and programmes, which is detrimental to their proper implementation.
- Make every effort to train the competent people in the managing authorities of the outermost regions.
- Launch twinning programmes between administrations, particularly those responsible for European funds, and develop the mobility of civil servants and citizens to raise awareness of the EU.
- Launch twinning programmes on EU administration, policy development and the management of European funds.

STRENGTHENING EUROPEAN CITIZENSHIP

- Deploy European Commission liaison offices and 'Maisons de l'Europe' in the outermost regions to create points of exchange and contact on location.
- Develop twinning to promote mobility and raise awareness of the EU.
- Introduce a European identity card and passport; freedom of movement of funds (with safeguards, of course) and facilities for living and working in Europe.

EDUCATION

- Maintain the level of investment in school infrastructure, building and renovating schools, improving reception conditions for pupils, putting an end to school rotation in primary education, and welcoming all children of school age by strengthening facilities for physical education.
- Encourage the development of high-quality teaching and educational projects with the support of Erasmus+.
- Create a European University of the Caribbean to raise Europe's profile in the French Antilles and French Guiana and encourage the emergence of a centre of excellence for research, particularly into the effects of climate change, the preservation of biodiversity, such as the mangroves, and the fight against sargassum.
- Develop a genuine language policy by promoting multilingualism from primary school onwards through language exchanges in each regional area and towards Europe.

DIGITAL TRANSITION

- Develop the ultra-high-speed internet network, renew submarine cables and deploy satellites.
- Define an action plan to offer a high-quality network connection for all by imposing a maximum price.

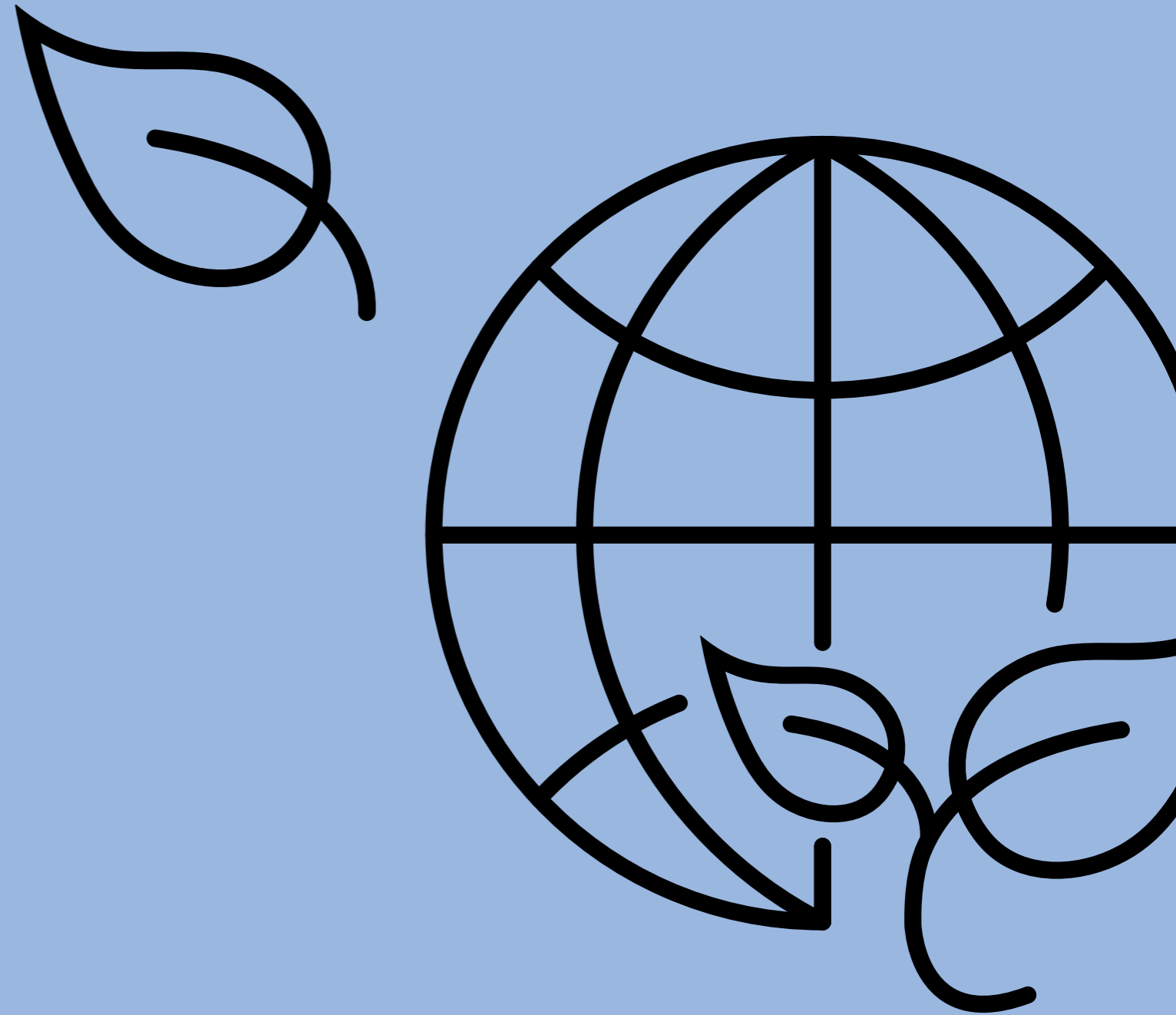

AI



Thank you !!





democrats.eu

 facebook.democrats.eu

 twitter.democrats.eu

 instagram.democrats.eu

Produced with the financial support of the European Parliament. The opinions expressed are those of the authors and do not necessarily reflect the position of the European Parliament.